



AQUAESTIL

REZERVNI DIJELOVI ZA TUŠ KABINE I PARAVANE



REZERVNI DIJELOVI PARAVANA ZA TUŠ KADE	
ZENITH Walk-In	4
ZENITH Wall+L+W	6
ZENITH Vario	8
ZENITH Glam	10
ZENITH Wall / Mirror	12
ZENITH - cijene rezervnih dijelova	15
ARTEGO D	16
ARTEGO W	18
ARTEGO D za nišu	20
ARTEGO 2D za nišu	22
ARTEGO - cijene rezervnih dijelova	25
ATLANTIS D	28
ATLANTIS DW	30
ATLANTIS W za D i DW	32
ATLANTIS D za nišu	34
ATLANTIS DW1 za nišu	36
ATLANTIS DW2 za nišu	38
ATLANTIS - cijene rezervnih dijelova	40
AURORA D+	42
AURORA D	44
AURORA W	46
AURORA D za nišu	48
AURORA 2D za nišu	50
AURORA W za D	52
AURORA polukružna	54
AURORA - cijene rezervnih dijelova	57
MARS D	58
MARS W	60
MARS D za nišu	62
MARS D II	64
MARS W II	66
MARS Glam D	68
MARS Glam W	70
MARS Glam D za nišu	72
MARS - cijene rezervnih dijelova	74
OASIS D i D+	76
OASIS W	78
OASIS D za nišu	80
OASIS 2D za nišu	82
OASIS D+p	84
OASIS D+p za nišu	86
OASIS - cijene rezervnih dijelova	88

REZERVNI DIJELOVI PARAVANA ZA TUŠ KADE

SAVANA D i D+	90
SAVANA W za D	92
SAVANA D za nišu	94
SAVANA 2D za nišu	96
SAVANA W+	98
SAVANA polukružna	100
SAVANA - cijene rezervnih dijelova	102
SOGNO D	104
SOGNO W za D	106
SOGNO D za nišu	108
SOGNO 2D za nišu	110
SOGNO - cijene rezervnih dijelova	112
LAGUNA II D	114
LAGUNA II za Krapinu	116
LAGUNA II polukružna	118
LAGUNA II za Čikolu	120
LAGUNA - cijene rezervnih dijelova	123







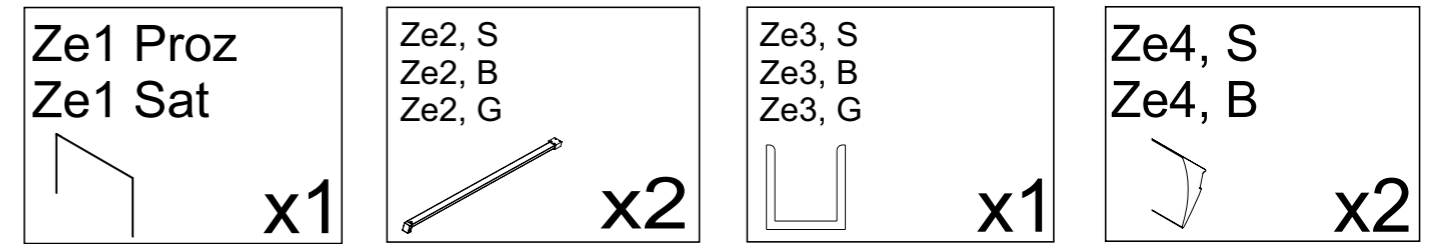
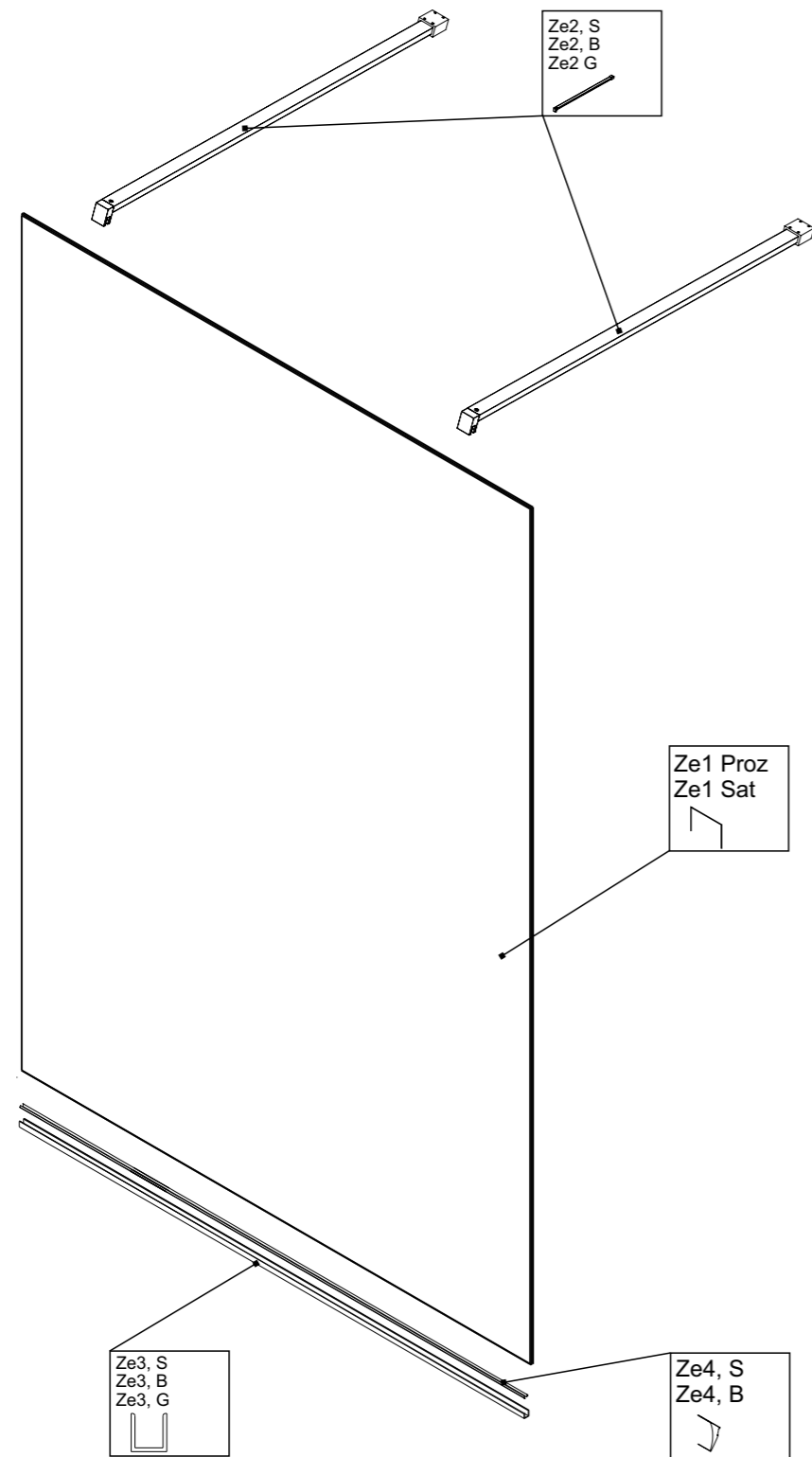

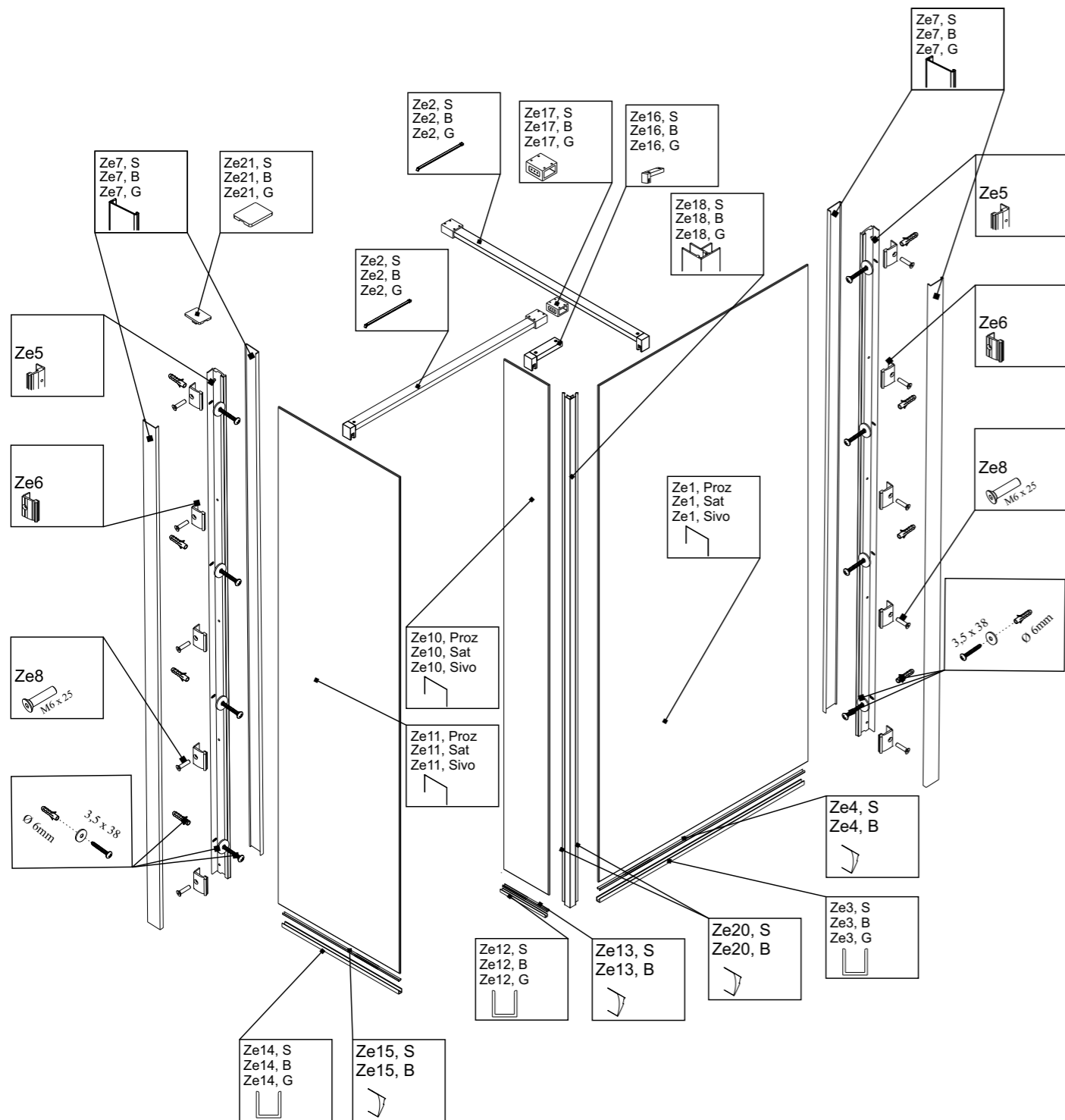

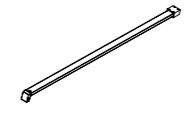
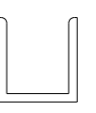

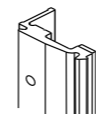
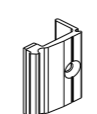
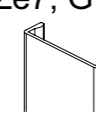

REZERVNI DIJELOVI PARAVANA ZA KADE

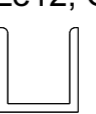
TITAN I	124
TITAN II	126
TITAN Plus	128
TITAN - cijene rezervnih dijelova	131
ATLANTIS D za kadu	132
ATLANTIS - cijene rezervnih dijelova	134
BETA I	136
BETA II	138
BETA III	140
BETA - cijene rezervnih dijelova	143
PANDORA D	144
PANDORA W za D	146
PANDORA 2D/2D za nišu	148
PANDORA W za 2D	150
PANDORA D za nišu	152
PANDORA - cijene rezervnih dijelova	154
PARMA	156
PARMA - cijene rezervnih dijelova	159
GALAXY	160
GALAXY - cijene rezervnih dijelova	163
GEMMA white	164
GEMMA silver	166
GEMMA - cijene rezervnih dijelova	169
OLBIA white	170
OLBIA silver	172
OLBIA - cijene rezervnih dijelova	175

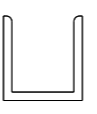

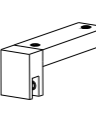
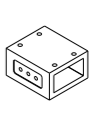
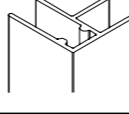

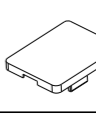

Ze1, Proz Ze1, Sat Ze1, Sivo  x1	Ze2, S Ze2, B Ze2, G  x2	Ze3, S Ze3, B Ze3, G  x1	Ze4, S Ze4, B  x2
Ze5  x2	Ze6  x10	Ze7, S Ze7, B Ze7, G  x4	Ze8  M6 x 25 x10
Ze10, Proz Ze10, Sat Ze10, Sivo  x1	Ze11, Proz Ze11, Sat Ze11, Sivo  x1	Ze12, S Ze12, B Ze12, G  x1	Ze13, S Ze13, B  x2
Ze14, S Ze14, B Ze14, G  x1	Ze15, S Ze15, B  x2	Ze16, S Ze16, B Ze16, G  x1	Ze17, S Ze17, B Ze17, G  x1
Ze18, S Ze18, B Ze18, G  x1	Ze20, S Ze20, B  x2	Ze21, S Ze21, B Ze21, G  x2	
Ze19  8X 8X 8X			

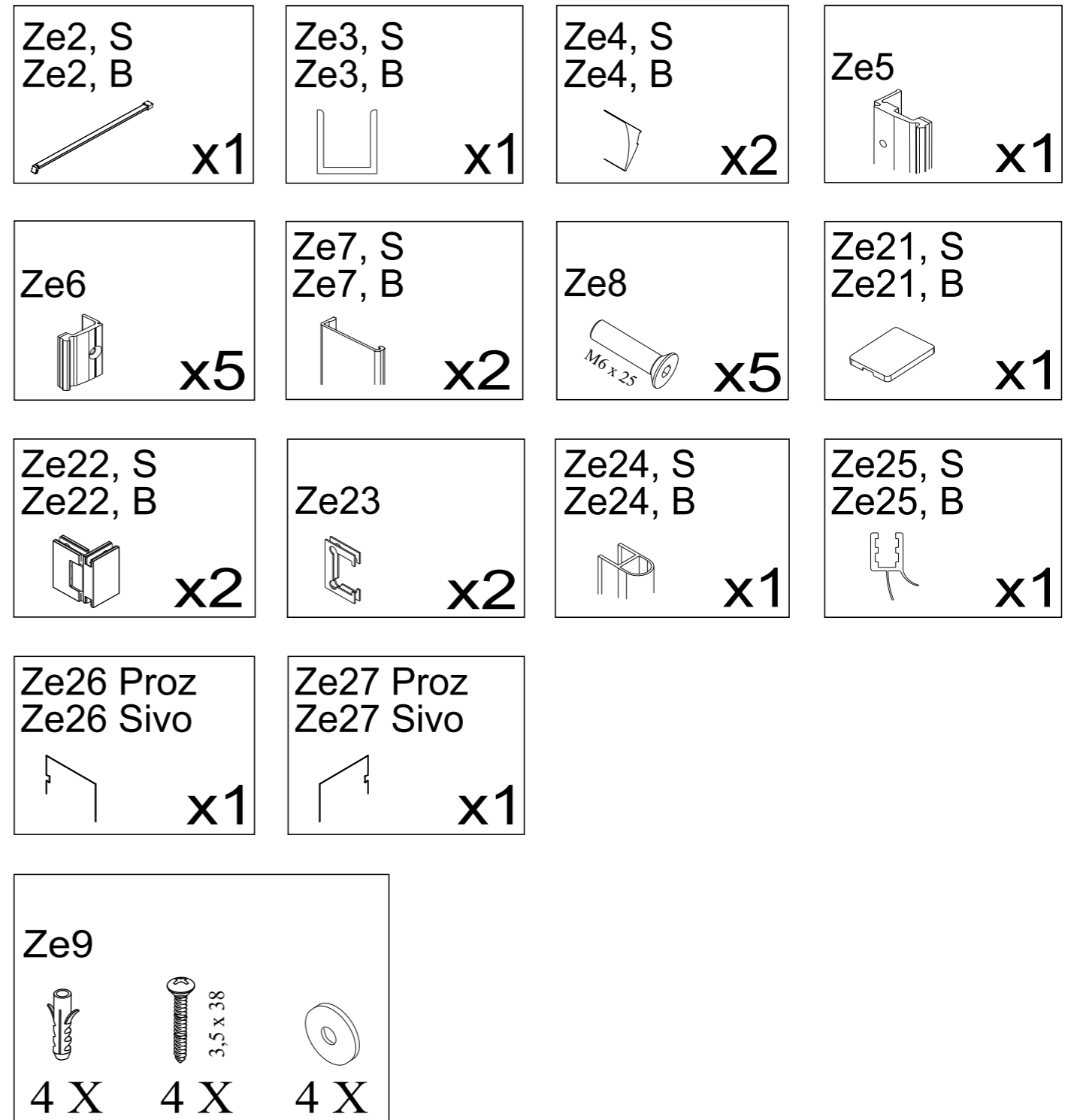
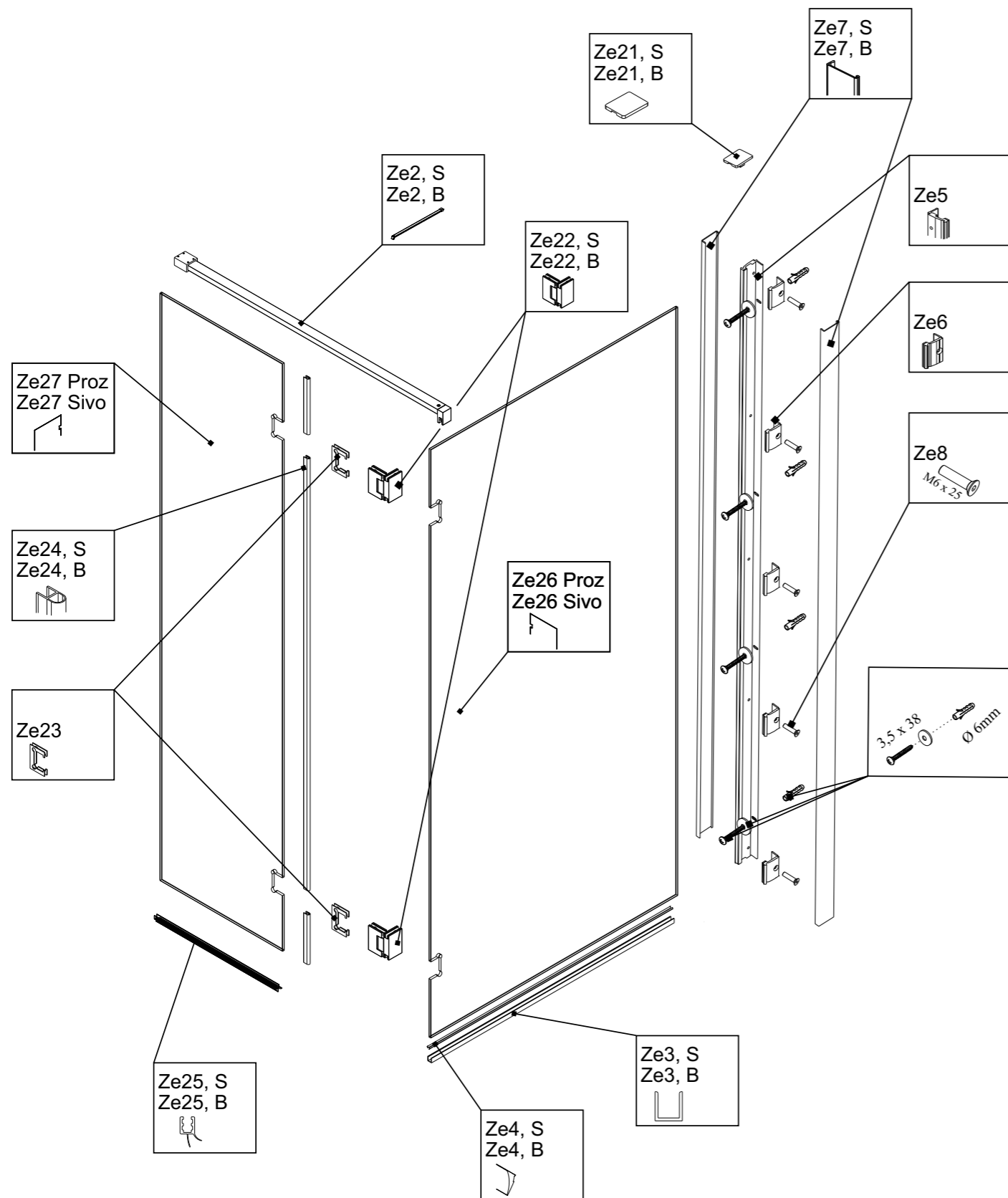

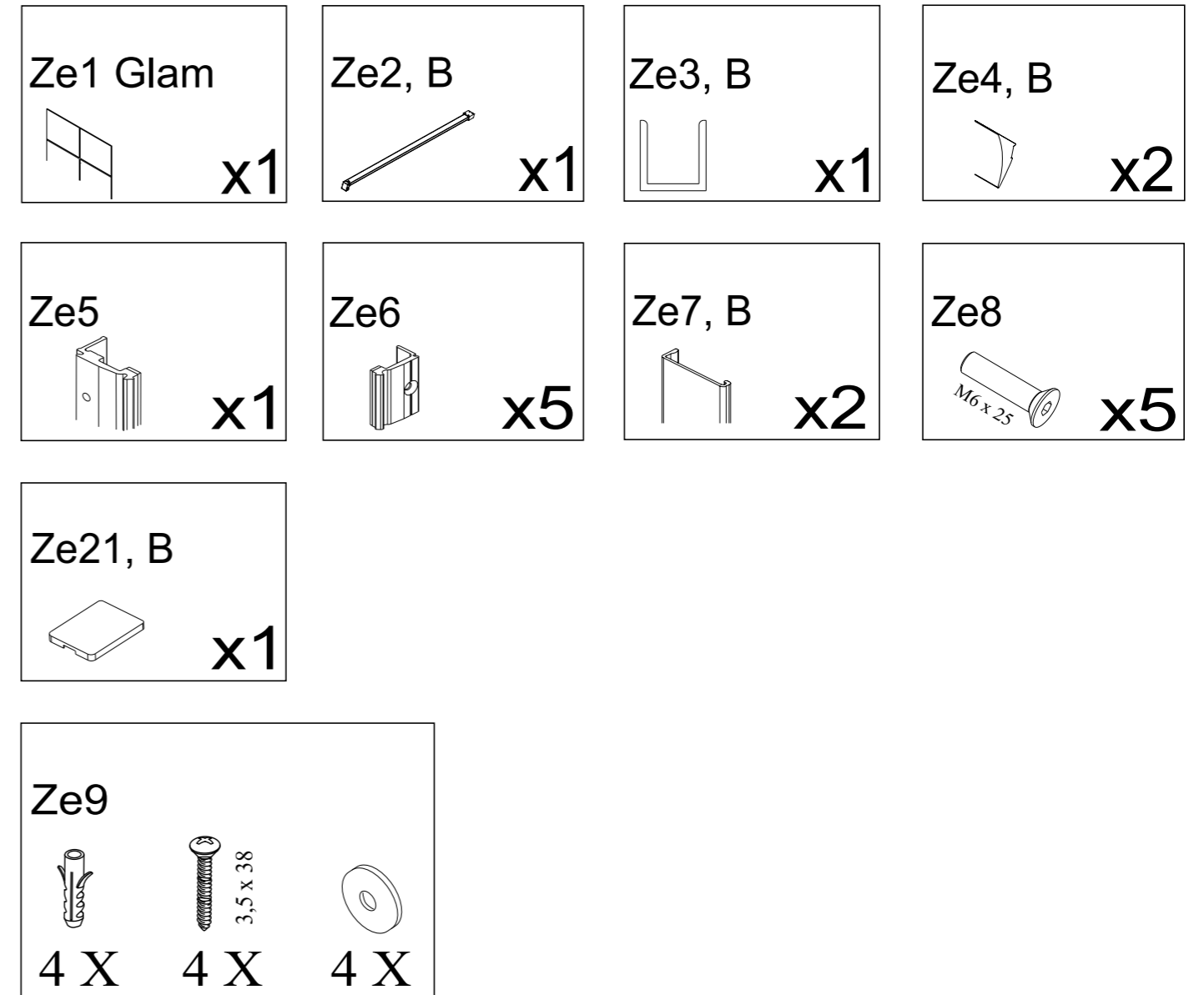
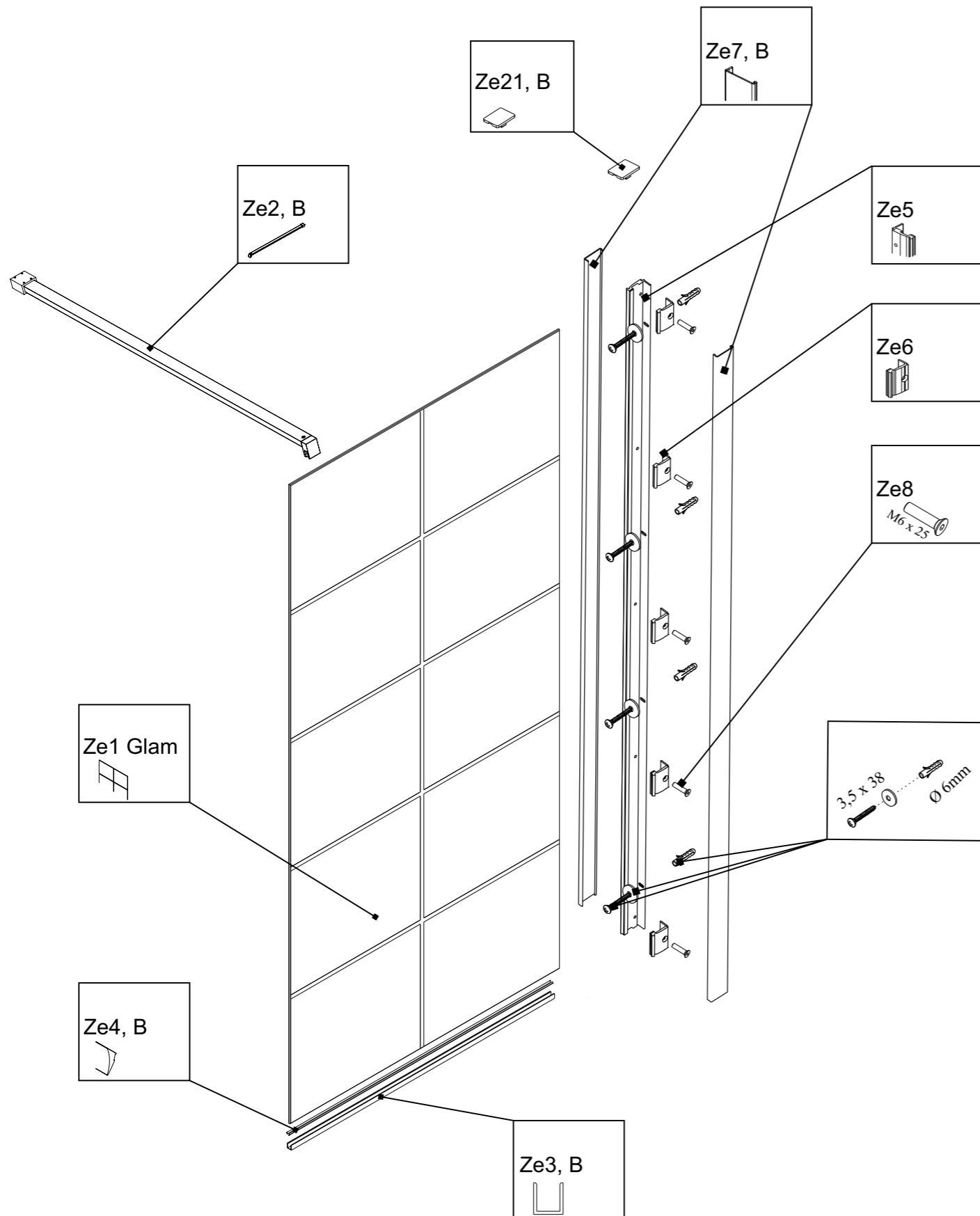

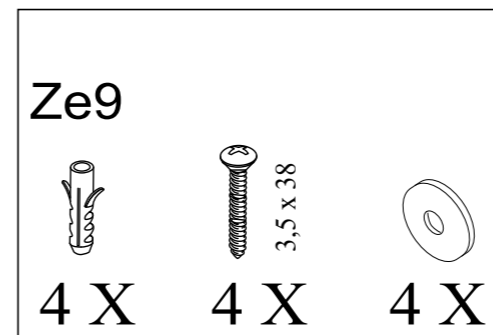
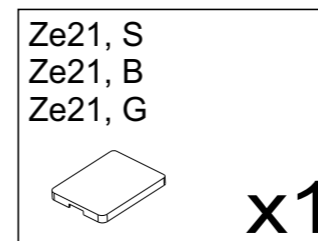
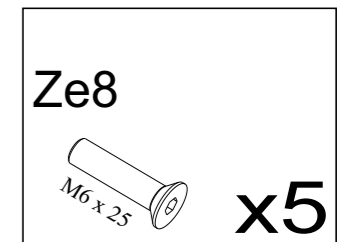
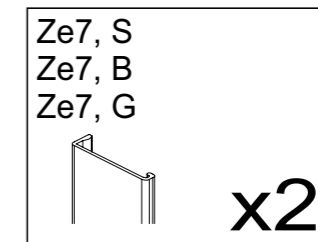
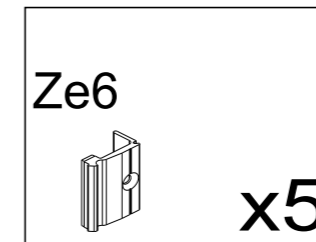
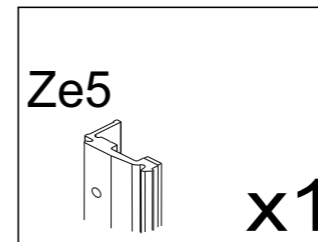
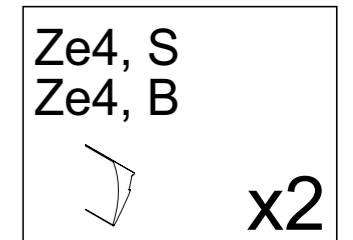
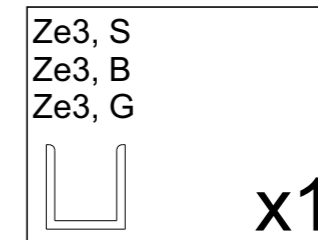
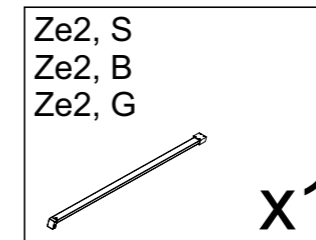
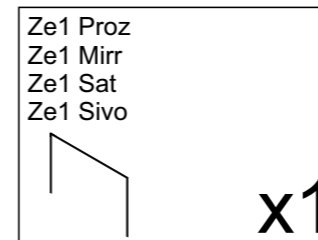
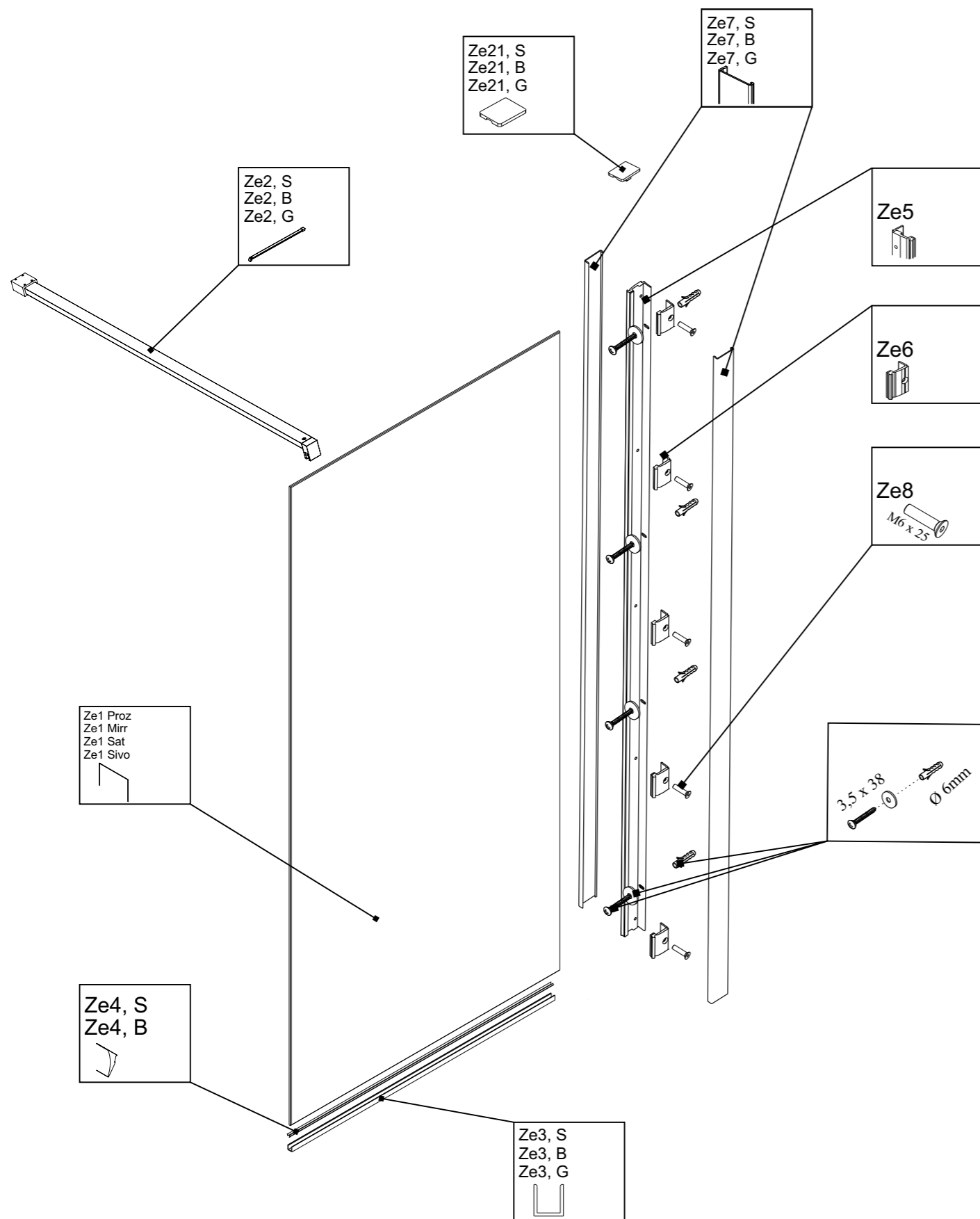





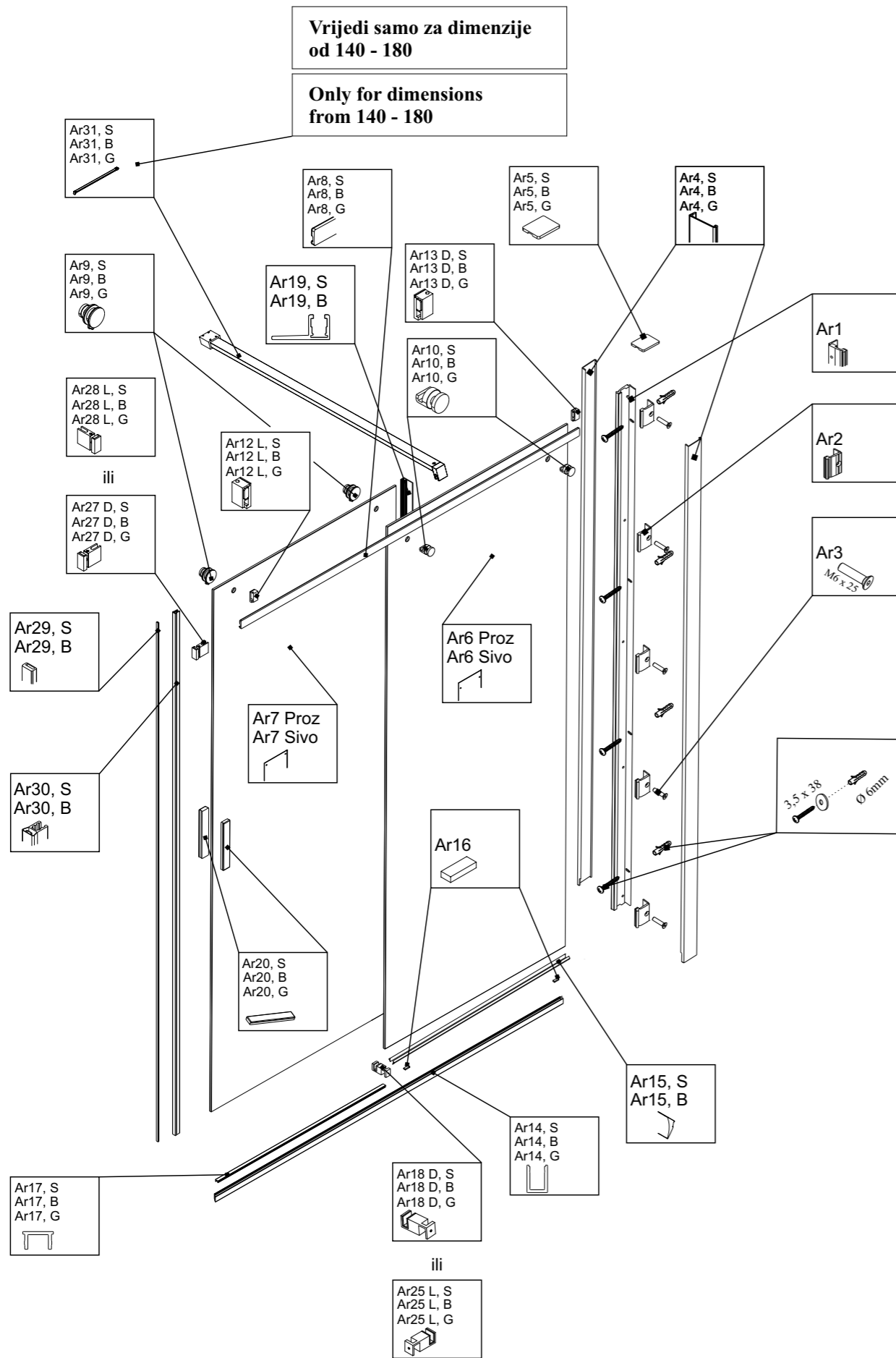



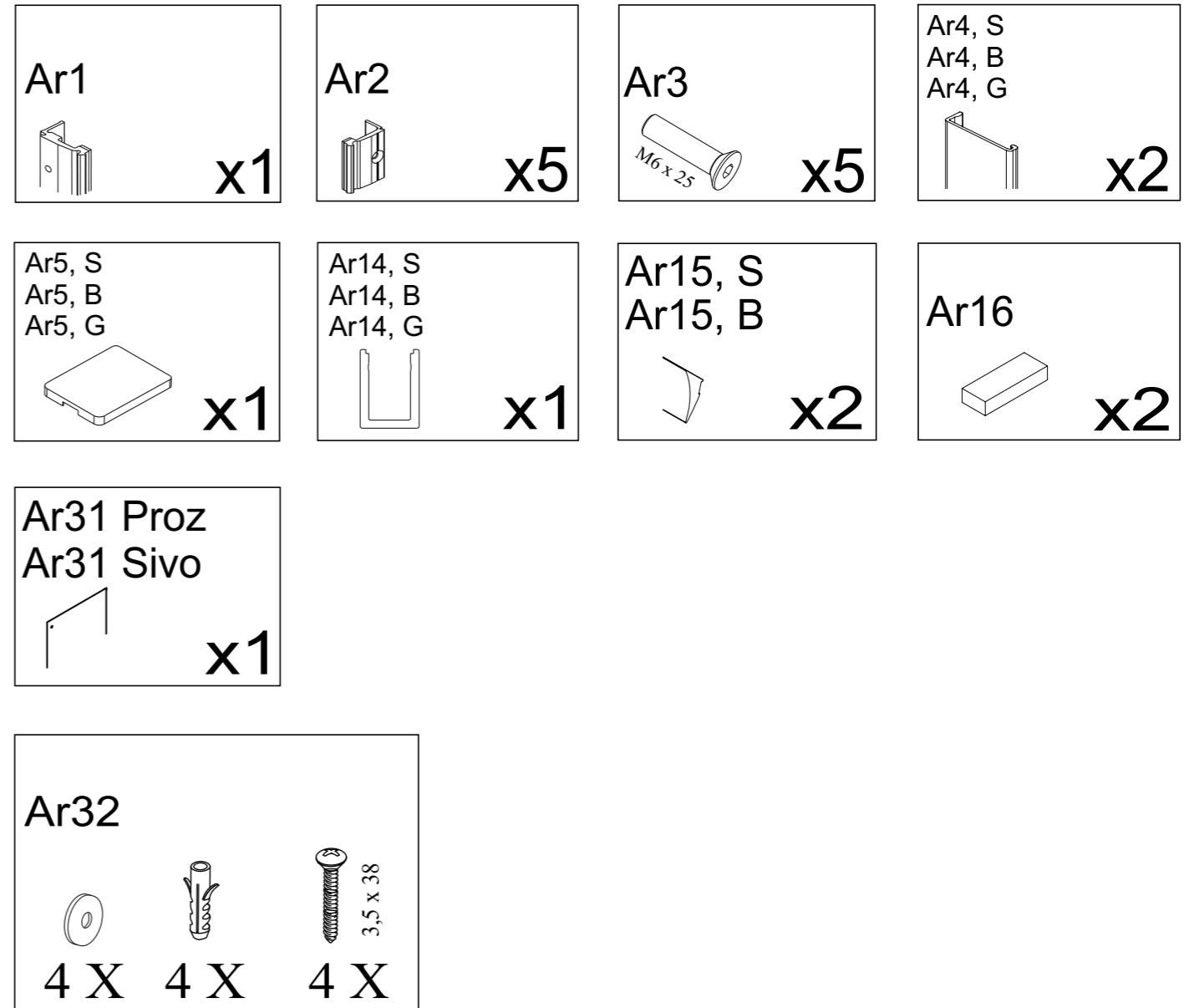
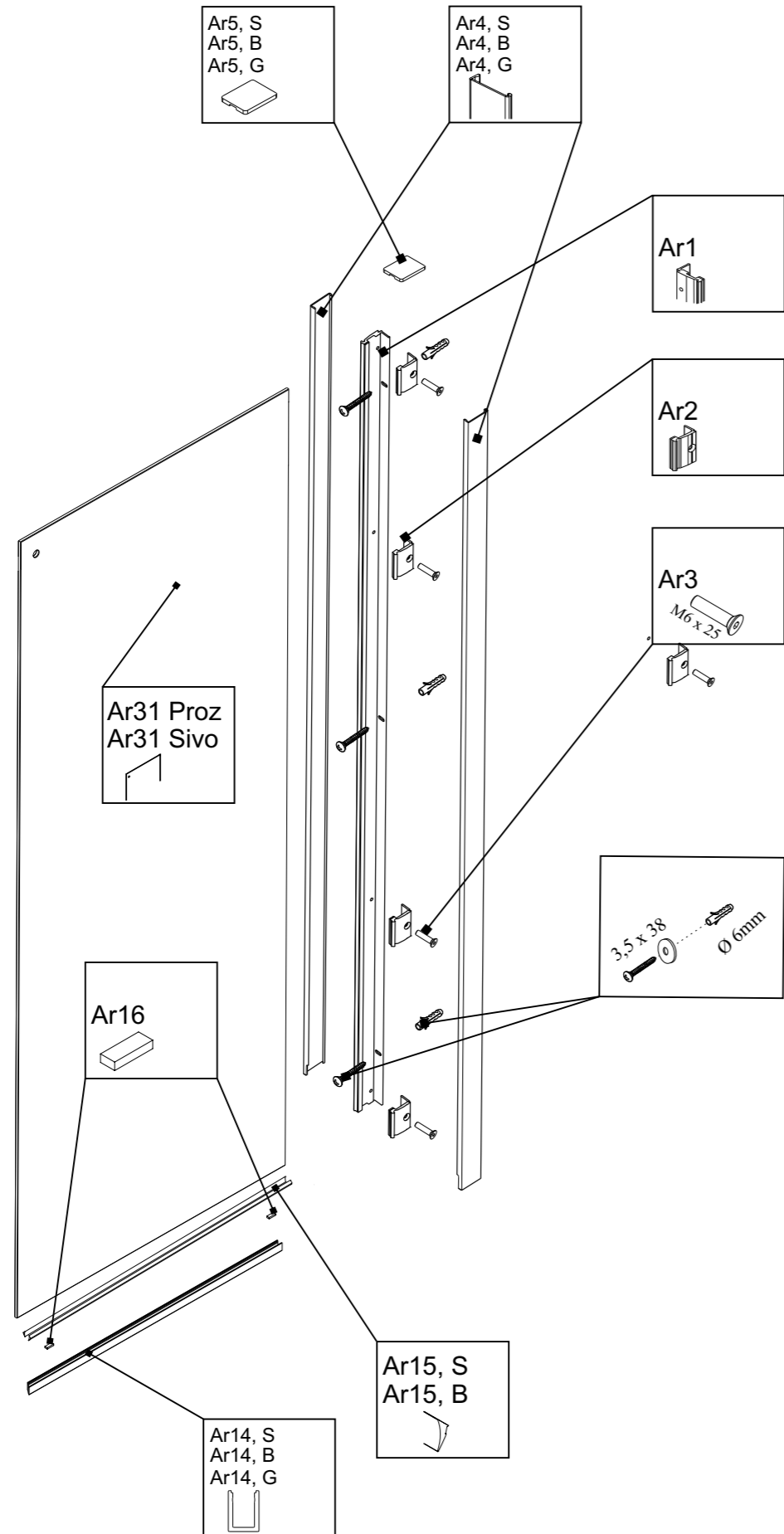

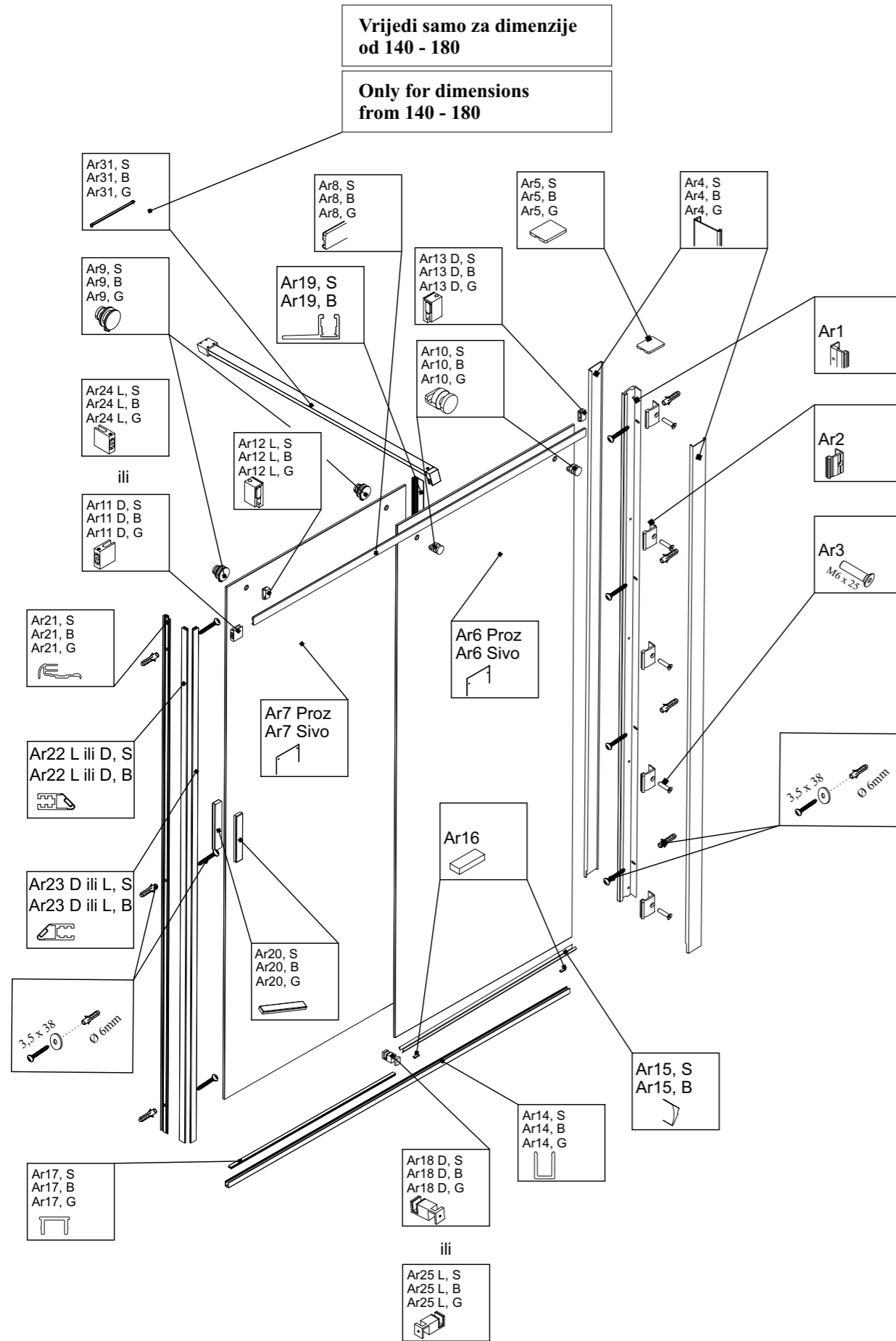





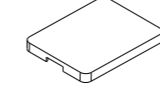



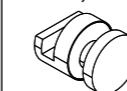

ZENITH WALK IN ZENITH WALL ZENITH MIRROR ZENITH GLAM ZENITH VARIO	Specif. br.	Šifra	Opis	
	Ze2, S	3113033	Šipka za fiksiranje L=990 mm, kvadratna, brill.	
	Ze2, B	3113084	Šipka za fiksiranje L=990 mm, kvadratna, crna mat	
	Ze2, G	3113290	Šipka za fiksiranje L=990 mm, kvadratna, zlatna	
	Ze3, S	6100034	Alu. profil U 15x15x15, L=2000 mm, silver	
	Ze3, B	6100034C	Alu. profil U 15x15x15, L=2000 mm, crni mat	
	Ze3, G	6100034Z	Alu. profil U 15x15x15, L=2000 mm, zlatna	
	Ze4, S Ze20, S Ze13, S Ze15, S	3112092	PVC profil obostrani 1 mm, L=2000 mm PVC profil obostrani 1 mm, L=1000 mm	
	Ze4, B Ze20, B Ze13, B Ze15, B	3113313	PVC profil obostrani 1 mm, L=2000 mm, crni PVC profil obostrani 1 mm, L=1000 mm, crni	
	Ze12, S Ze14, S	6100119	Alu. profil U 15x15x15, L=1000 mm, silver	
	Ze12, B Ze14, B	6100120	Alu. profil U 15x15x15, L=1000 mm, crni mat	
	Ze12, G Ze14, G	6100119G	Alu. profil U 15x15x15, L=1000 mm, zlatna	
		Ze16, S	3113032	Šipka za fiksiranje L=100 mm, kvadratna, brill.
		Ze16, B	3113086	Šipka za fiksiranje L=100 mm, kvadratna, crna mat
Ze16, G		3113292	Šipka za fiksiranje L=100 mm, kvadratna, zlatna	
	Ze17, S	3113047	Spojni element za kvadratnu šipku, brill.	
	Ze17, B	3113148	Spojni element za kvadratnu šipku, crna mat	
	Ze17, G	3113293	Spojni element za kvadratnu šipku, zlatna	
	Ze18, S	6100088	Alu. profil R11391, brillant, L=2004 mm	
	Ze18, B	6100089	Alu. profil R11391, crni mat, L=2004 mm	
	Ze18, G	6100205	Alu. profil R11391, zlatna, L=2004 mm	
	Ze21, S	3113209	Poklopac za zidni profil Eris - chrom	
	Ze21, B	3113265	Poklopac za zidni profil Eris - crni	
	Ze21, G	6100206	Poklopac za zidni profil Eris - zlatna	
	Ze22, S	3113357	Pant 368V staklo-staklo, kutni, chrom	
	Ze22, B	3113358	Pant 368V staklo-staklo, kutni, crna mat	
	Ze23	6100207	Podloška za pant 368V staklo-staklo - PAR	
	Ze24, S	3112074	PVC profil G 058 V8, L=2200 mm transp	
	Ze24, B	3113321	PVC profil G 058 V8, L=2200 mm crna	
	Ze25, S	3112075	PVC profil G 023, ala 10,5, V8, L=2200 mm transp	
	Ze25, B	3113322	PVC profil G 023, ala 10,5, V8, L=2200 mm crna	



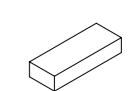
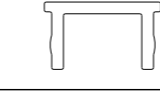
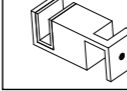

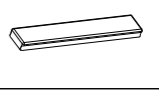
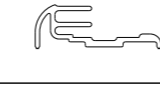
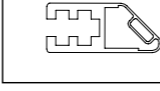
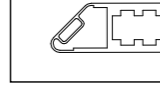

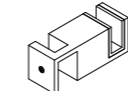

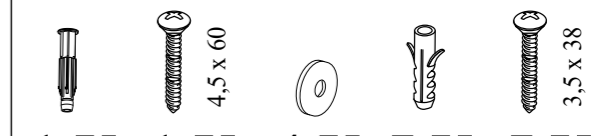

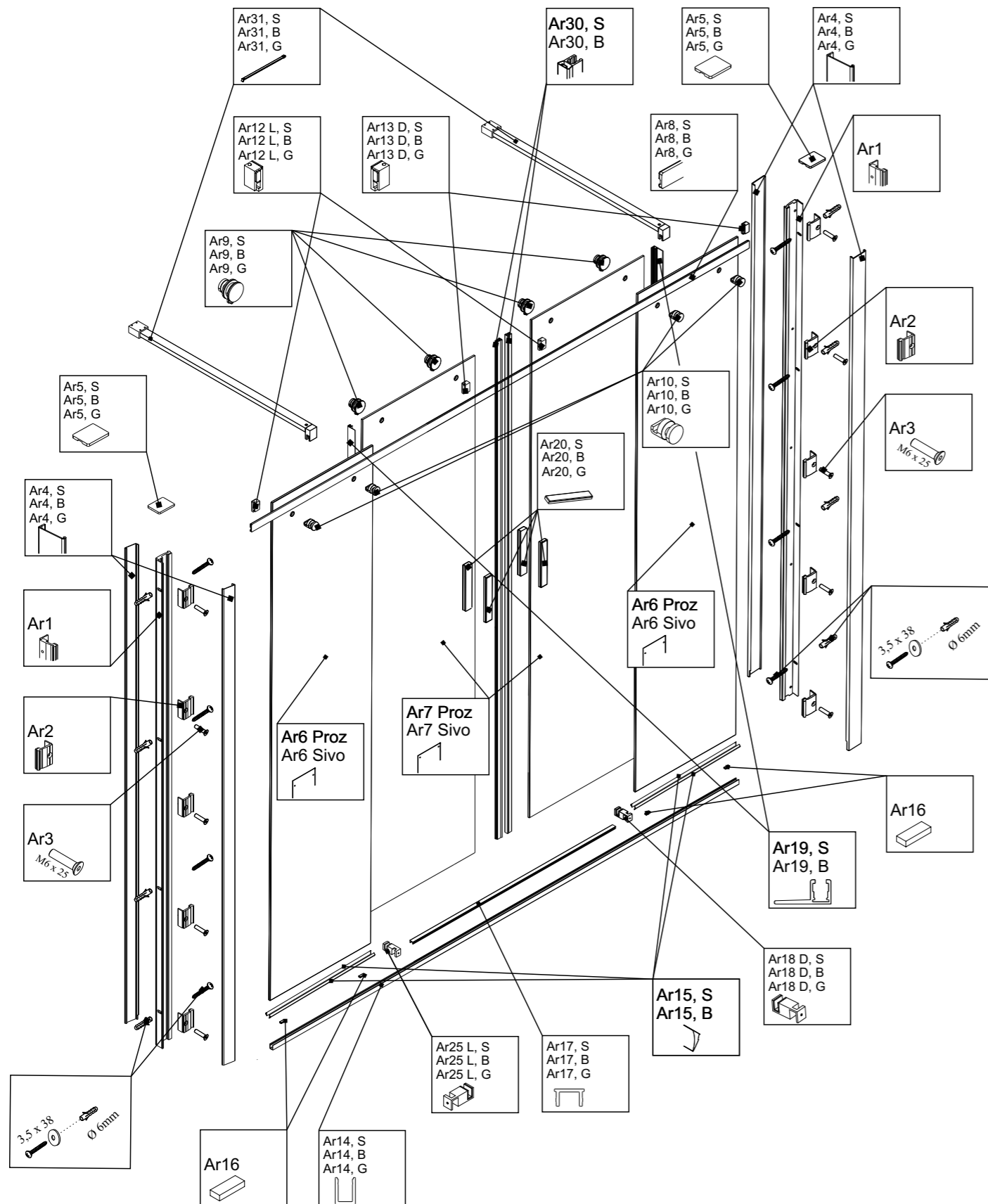

Ar1 x1	Ar2 x5	Ar3 M6 x 25 x5	Ar4, S Ar4, B Ar4, G x2
Ar5, S Ar5, B Ar5, G x1	Ar6 Proz Ar6 Sivo x1	Ar7 Proz Ar7 Sivo x1	Ar8, S Ar8, B Ar8, G x1
Ar9, S Ar9, B Ar9, G x2	Ar10, S Ar10, B Ar10, G x2	Ar12 L, S Ar12 L, B Ar12 L, G x1	Ar13 D, S Ar13 D, B Ar13 D, G x1
Ar14, S Ar14, B Ar14, G x1	Ar15, S Ar15, B x2	Ar16 x2	Ar17, S Ar17, B Ar17, G x1
Ar18 D, S Ar18 D, B Ar18 D, G x1	Ar19, S Ar19, B x1	Ar20, S Ar20, B Ar20, G x2	Ar25 L, S Ar25 L, B Ar25 L, G x1
Ar27 D, S Ar27 D, B Ar27 D, G x1	Ar28 L, S Ar28 L, B Ar28 L, G x1	Ar29, S Ar29, B x1	Ar30, S Ar30, B x1
Ar31, S Ar31, B Ar31, G x1	Ar33 4 X 7 X 7 X		



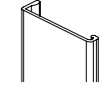
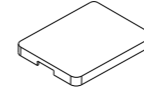
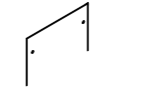
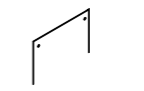
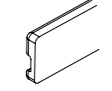
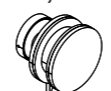
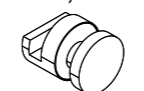
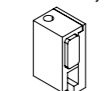
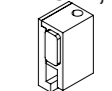

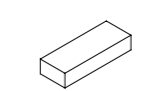

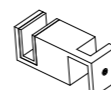
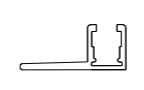
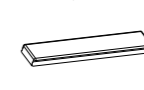
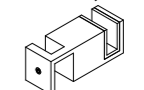
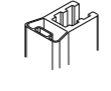















Ar1  x1	Ar2  x5	Ar3  M6 x 25 x5	Ar4, S Ar4, B Ar4, G  x2
Ar5, S Ar5, B Ar5, G  x1	Ar6 Proz Ar6 Sivo  x1	Ar7 Proz Ar7 Sivo  x1	Ar8, S Ar8, B Ar8, G  x1
Ar9, S Ar9, B Ar9, G  x2	Ar10, S Ar10, B Ar10, G  x2	Ar11 D, S Ar11 D, B Ar11 D, G  x1	Ar12 L, S Ar12 L, B Ar12 L, G  x1
Ar13 D, S Ar13 D, B Ar13 D, G  x1	Ar14, S Ar14, B Ar14, G  x1	Ar15, S Ar15, B  x2	Ar16  x2
Ar17, S Ar17, B Ar17, G  x1	Ar18 D, S Ar18 D, B Ar18 D, G  x1	Ar19, S Ar19, B  x1	Ar20, S Ar20, B Ar20, G  x2
Ar21, S Ar21, B Ar21, G  x1	Ar22 L ili D, S Ar22 L ili D, B  x1	Ar23 D ili L, S Ar23 D ili L, B  x1	Ar24 L, S Ar24 L, B Ar24 L, G  x1
Ar25 L, S Ar25 L, B Ar25 L, G  x1	Ar31, S Ar31, B Ar31, G  x1	Ar26  1 X 1 X 4 X 7 X 7 X	





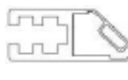

Ar1  x2	Ar2  x10	Ar3  M6 x 25 x10	Ar4, S Ar4, B Ar4, G  x4
Ar5, S Ar5, B Ar5, G  x2	Ar6 Proz Ar6 Sivo  x2	Ar7 Proz Ar7 Sivo  x2	Ar8, S Ar8, B Ar8, G  x1
Ar9, S Ar9, B Ar9, G  x4	Ar10, S Ar10, B Ar10, G  x4	Ar12 L, S Ar12 L, B Ar12 L, G  x2	Ar13 D, S Ar13 D, B Ar13 D, G  x2
Ar14, S Ar14, B Ar14, G  x1	Ar15, S Ar15, B  x4	Ar16  x4	Ar17, S Ar17, B Ar17, G  x1
Ar18 D, S Ar18 D, B Ar18 D, G  x1	Ar19, S Ar19, B  x2	Ar20, S Ar20, B Ar20, G  x4	Ar25 L, S Ar25 L, B Ar25 L, G  x1
Ar30, S Ar30, B  x2	Ar31, S Ar31, B Ar31, G  x2		
Ar33  8 X 8 X 8 X			









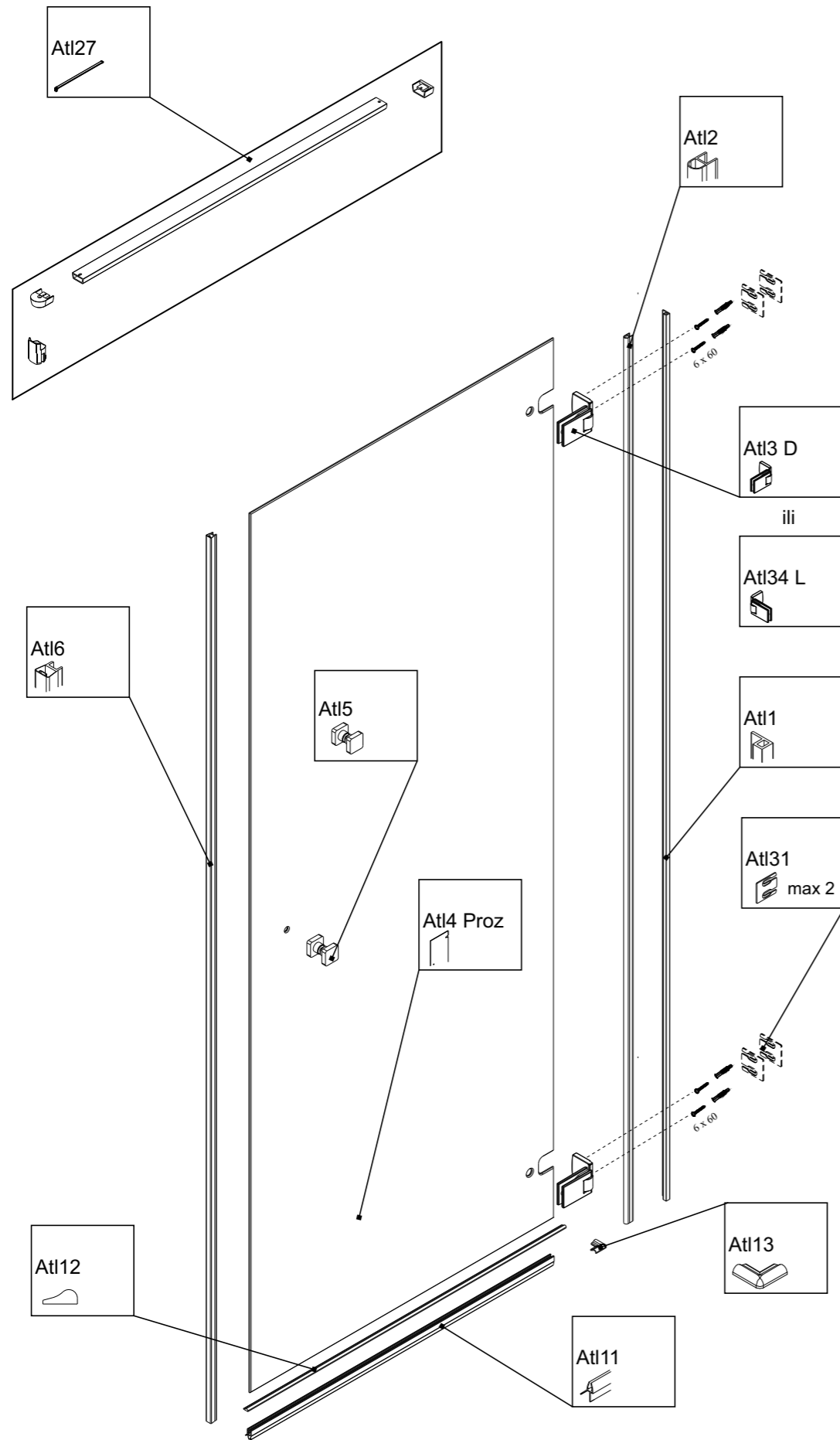

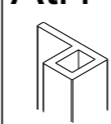
ARTEGO	Specif. br.	Šifra	Opis
	Ar3	3113203	Vijak M6x25 DIN 7991 rostfrei A2
	Ar5 S	3113209	Poklopac za zidni profil Eris - chrom
	Ar5 B	3113265	Poklopac za zidni profil Eris - crni
	Ar5 G	6100206	Poklopac za zidni profil Eris - zlatna
	Ar9 S	3113068	Kotač za kliznu tuš kabinu, inox/sjaj
	Ar9 B	3113068C	Kotač za kliznu tuš kabinu, inox/crna mat
	Ar9 G	3113068Z	Kotač za kliznu tuš kabinu, inox/zlatna
	Ar10 S	3113070	Prihvati fiksno staklo na vodilicu, inox/sjaj
	Ar10 B	3113070C	Prihvati fiksno staklo na vodilicu, inox/crna mat
	Ar10 G	3113070Z	Prihvati fiksno staklo na vodilicu, inox/zlatna
	Ar11 D, S	3113072	Prihvati vodilice na zid, inox/sjaj, D
	Ar11 D, B	3113072C	Prihvati vodilice na zid, inox/crna mat, D
	Ar11 D, G	3113072Z	Prihvati vodilice na zid, inox/zlatna, D
	Ar12 L, S	3113075	Stoper za kliznu tuš kabinu, inox/sjaj, L
	Ar12 L, B	3113075C	Stoper za kliznu tuš kabinu, inox/crna mat, L
	Ar12 L, G	3113075Z	Stoper za kliznu tuš kabinu, inox/zlatna, L
	Ar13 D, S	3113076	Stoper za kliznu tuš kabinu, inox/sjaj, D
	Ar13 D, B	3113076C	Stoper za kliznu tuš kabinu, inox/crna mat, D
	Ar13 D, G	3113076Z	Stoper za kliznu tuš kabinu, inox/zlatna, D
	Ar14, S	6104051	Alu. U profil sjaj 19x14 mm, L=1000mm (Artego W)
	Ar14, S	6100114	Alu. U profil sjaj 19x14 mm, L=2000 mm (Artego D, D za nišu)
	Ar14, B	6100092	Alu. profil U crna mat 19x14 mm, L=1000 mm (Artego W)
	Ar14, B	6100115	Alu. profil U crna mat 19x14 mm, L=2000 mm (Artego D, D za nišu)
	Ar14, G	6100208	Alu. profil U zlatna 19x14 mm, L=1000 mm (Artego W)
	Ar14, G	6100209	Alu. profil U zlatna 19x14 mm, L=2000 mm (Artego D, D za nišu)
	Ar15, S	3112092	PVC profil obostrani transparent 1 mm, L=1000 mm
	Ar15, B	3113313	PVC profil obostrani 1 mm, crni, L=1000 mm
	Ar16	6100093	PVC odstožnik 50x10x6mm, bijela

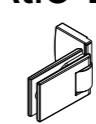
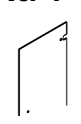
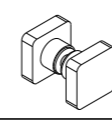
ARTEGO	Specif. br.	Šifra	Opis
	Ar17, S	6104050	Poklopac za Alu. U profil silver 19x14, L=1000mm
	Ar17, B	6100094	Poklopac za Alu. U profil crni 19x14, L=1000 mm
	Ar17, G	6100210	Poklopac za Alu. U zlatna 19x14, L=1000 mm
	Ar18 D, S	3113069	Donja ušica za klizno staklo, inox/sjaj, D
	Ar18 D, B	3113069C	Donja ušica za klizno staklo, inox/crna mat, D
	Ar18 D, G	3113069Z	Donja ušica za klizno staklo, inox/zlatna, D
	Ar19, S	3112099	PVC profil G 018, ala 23, V8, L=2200 mm, transp
	Ar19, B	3113311	PVC profil G 018, ala 23, V8, L=2200 mm, crni
	Ar20, S	6100095	Pravokutna ručkica 30x16x180, Alu, brillant
	Ar20, B	6100096	Pravokutna ručkica 30x16x180, Alu, crna mat
	Ar20, G	6100204	Pravokutna ručkica 30x16x180, Alu, zlatna
	Ar21, S	6100098	Alu. profil R10699, brillant, L=2000 mm_OTKID
	Ar21, B	6100099	Alu. profil R10699, crna mat, L=2000 mm_OTKID
	Ar21, G	6100203	Alu. profil R10699, zlatna, 2000 mm_OTKID
	Ar22 L ili D, S	3112033	PVC profil mag. M122 L, V6, L=2200mm azur.sivi mag
		3112053	PVC profil mag M122 D, V6, L=2200mm azur.sivi mag
	Ar22 L ili D, B	3113310	PVC profil mag. M122 L, V6, L=2200 mm crni
		3113309	PVC profil mag. M122 D, V6, L=2200 mm crni
	Ar23 D ili L, S	3113314	PVC profil mag M122 D, V8, L=2200 mm azur.sivi mag
		3113315	PVC profil mag M122 L, V8, L=2200 mm azur.sivi mag
	Ar23 D ili L, B	3113316	PVC profil mag. M122 D, V8, L=2200 mm crni
		3113317	PVC profil mag. M122 L, V8, L=2200 mm crni
	Ar24 L, S	3113071	Prihvat vodilice na zid, inox/sjaj, L
	Ar24 L, B	3113071C	Prihvat vodilice na zid, inox/crna mat, L
	Ar24 L, G	3113071Z	Prihvat vodilice na zid, inox/zlatna, L
	Ar25 L, S	3113069	Donja ušica za klizno staklo, inox/sjaj, D
	Ar25 L, B	3113069C	Donja ušica za klizno staklo, inox/crna mat, D
	Ar25 L, G	3113069Z	Donja ušica za klizno staklo, inox/zlatna, D
	Ar27 D, S	3113074	Prihvat vodilice na staklo, inox/sjaj, D
	Ar27 D, B	3113074C	Prihvat vodilice na staklo, inox/crna mat, D
	Ar27 D, G	3113074Z	Prihvat vodilice na staklo, inox/zlatni, D

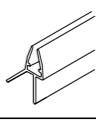

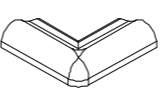

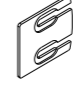
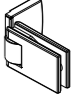
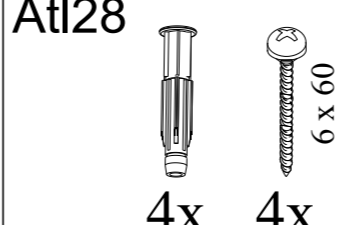

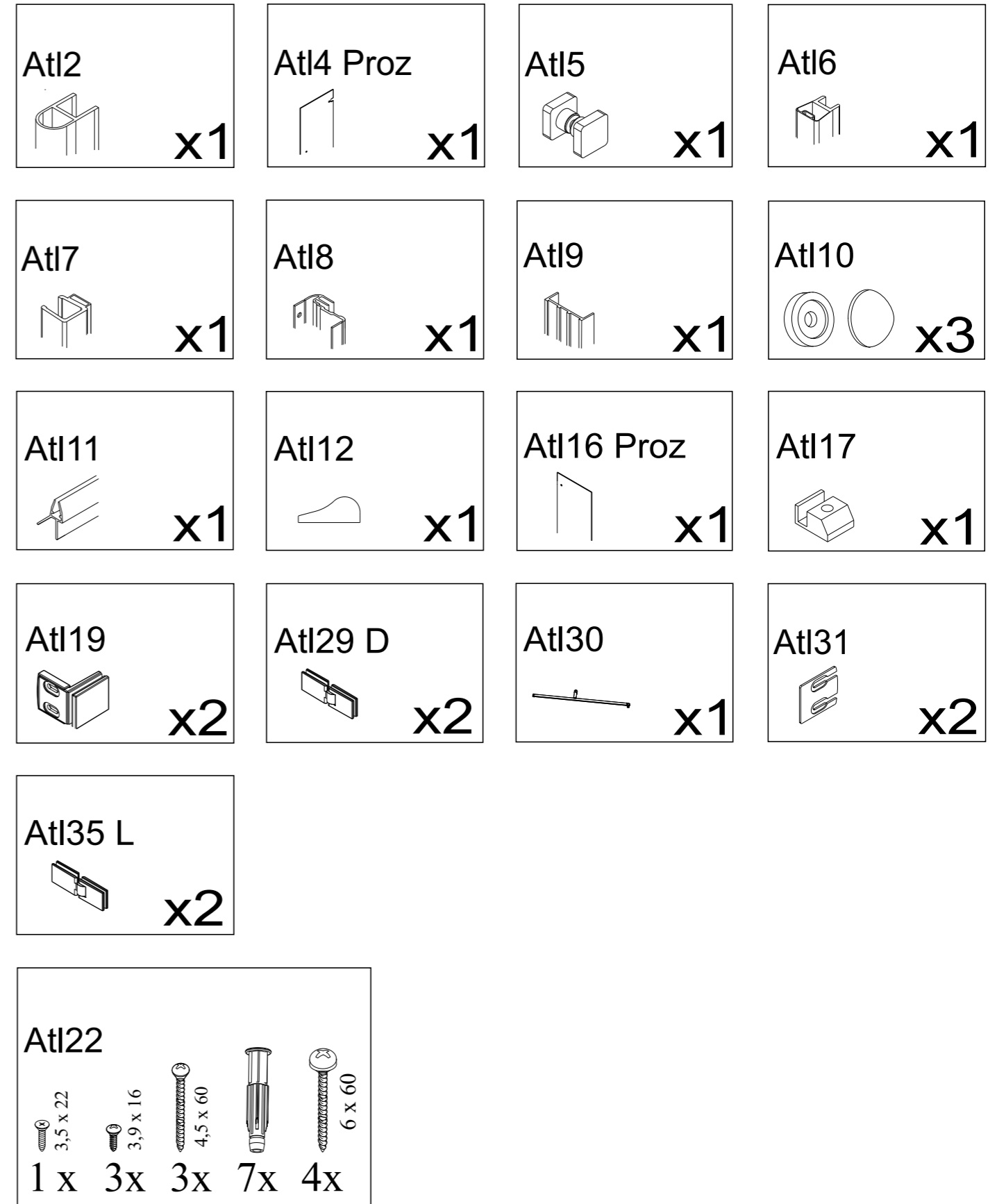
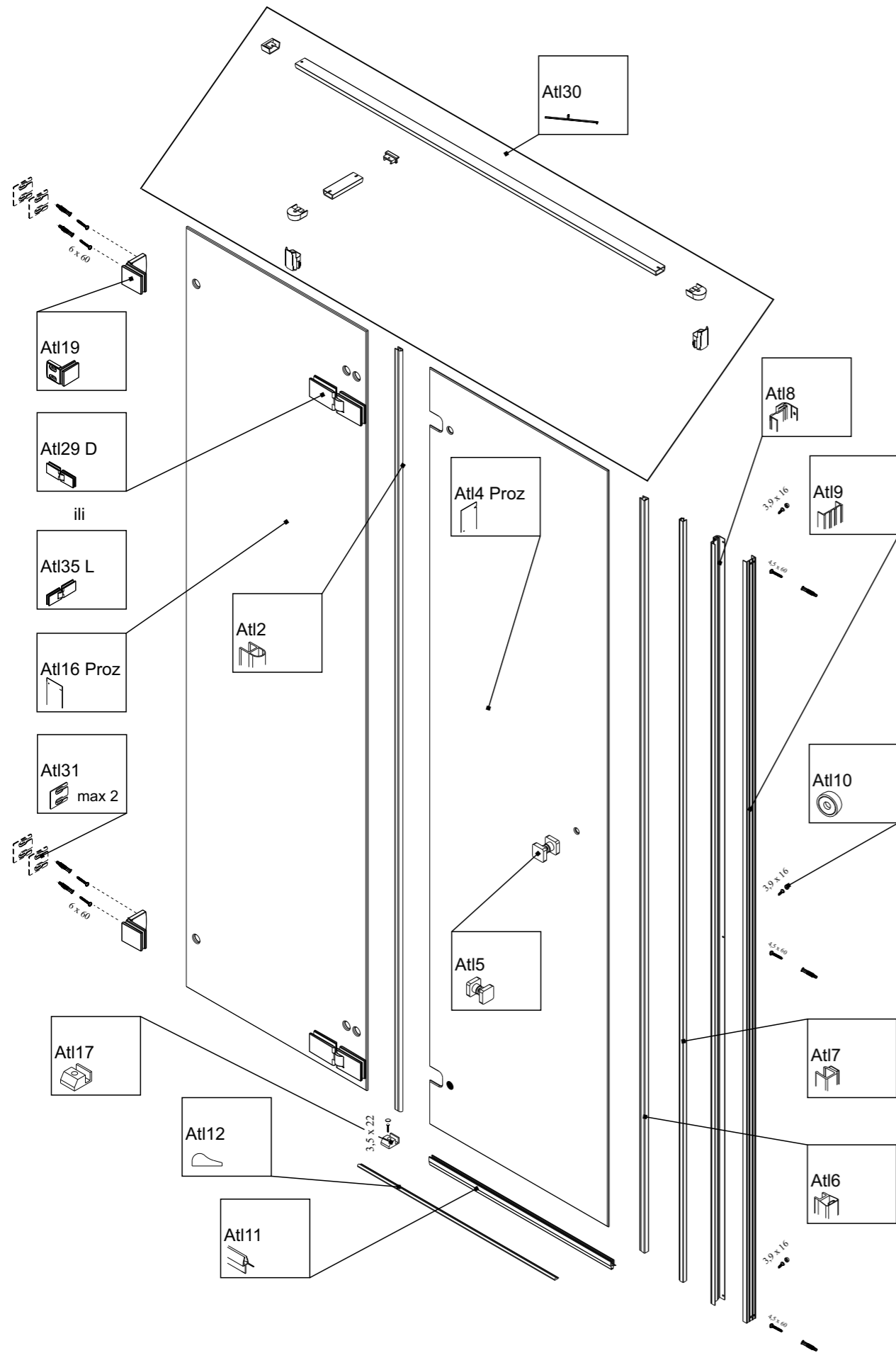
ARTEGO	Specif. br.	Šifra	Opis
	Ar28 L, S	3113073	Prihvat vodilice na staklo, inox/sjaj, L
	Ar28 L, B	3113073C	Prihvat vodilice na staklo, inox/crna mat, L
	Ar28 L, G	3113073Z	Prihvat vodilice na staklo, inox/zlatna, L
	Ar29, S	3112096	PVC profil mag. 6x2R, L=2200 mm, siva
	Ar29, B	3113320	PVC profil mag. 6x2R, 2200 mm, crna
	Ar30, S	3113302	PVC profil mag M 118, V8 L=2200 mm, transparent
	Ar30, B	3113312	PVC profil mag M 118, V8 L=2200 mm, crna
	Ar31, S	3113033	Šipka za fiksiranje L=990 mm, kvadratna, brill.
	Ar31, B	3113084	Šipka za fiksiranje L=990 mm, kvadratna, crna mat
	Ar31, G	3113290	Šipka za fiksiranje L=990 mm, kvadratna, zlatna

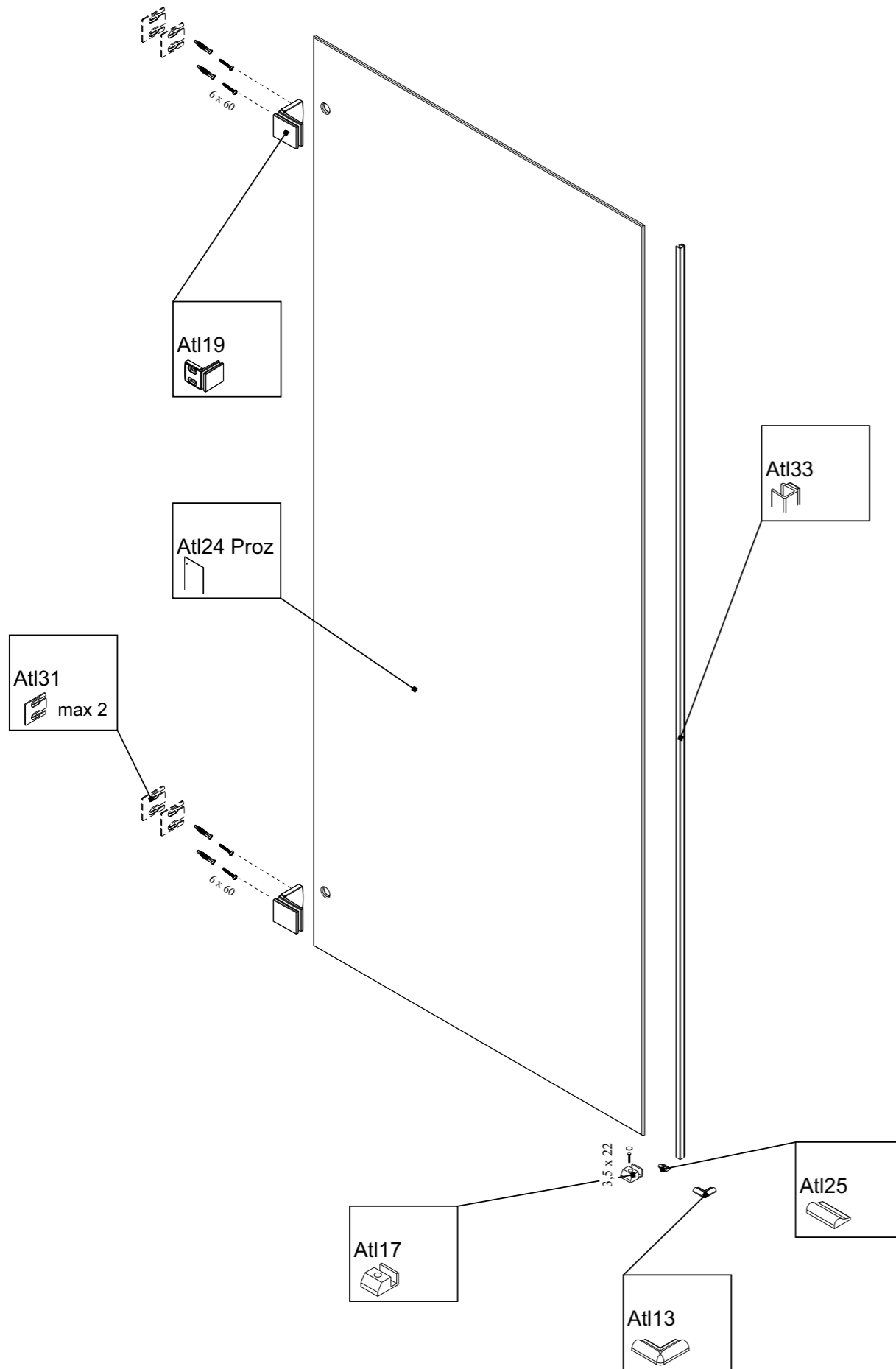

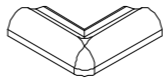

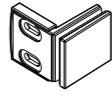
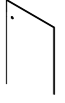





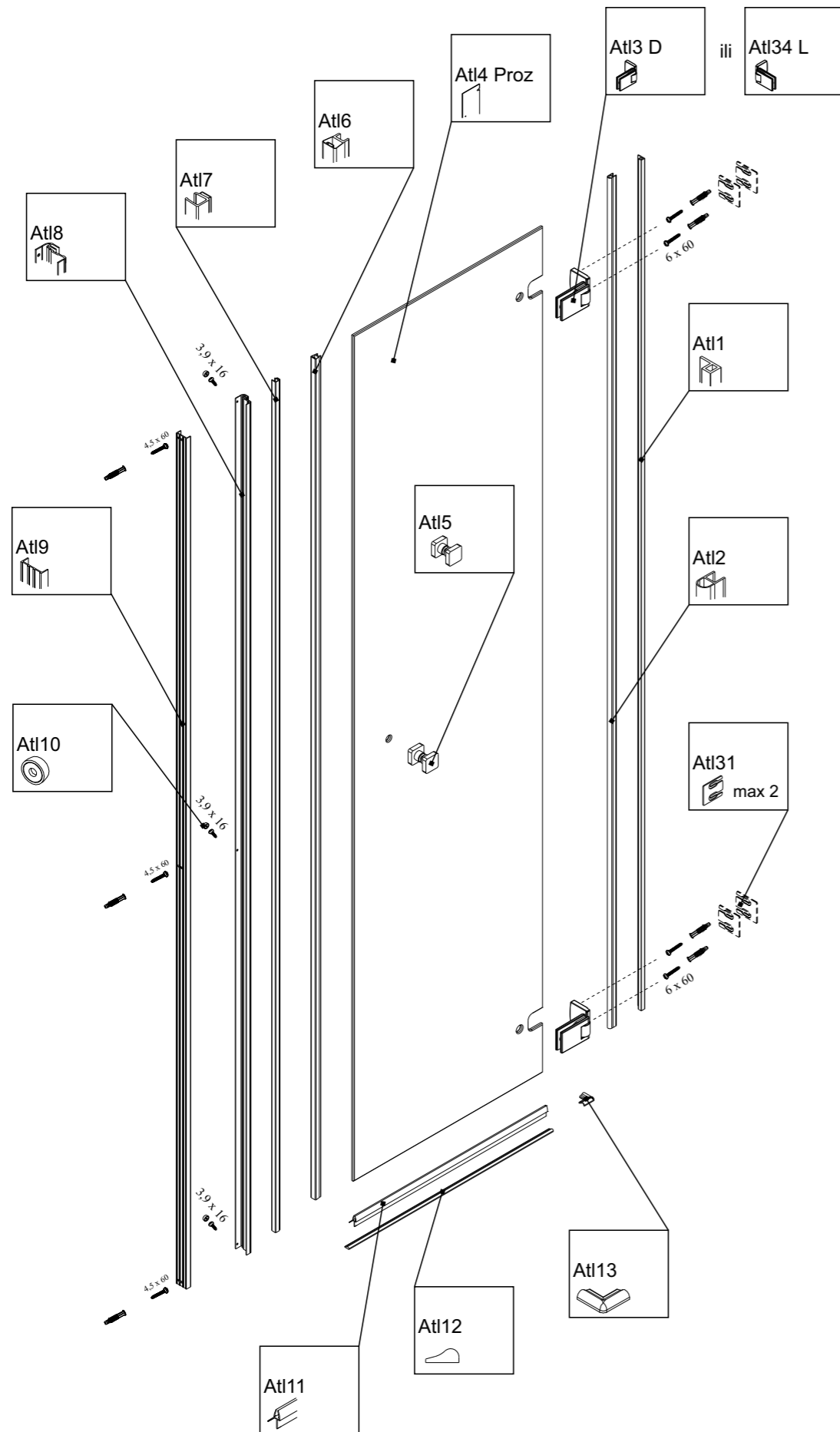





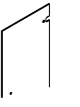
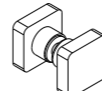

 <p>AtI1 x1</p>	 <p>AtI2 x1</p>	 <p>AtI3 D x2</p>	 <p>AtI4 Proz x1</p>
 <p>AtI5 x1</p>	 <p>AtI6 x1</p>	 <p>AtI11 x1</p>	 <p>AtI12 x1</p>
 <p>AtI13 x1</p>	 <p>AtI27 x1</p>	 <p>AtI31 x2</p>	 <p>AtI34 L x2</p>
 <p>AtI28 4x 4x 6 x 60</p>			

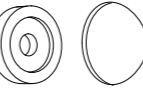

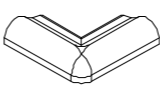







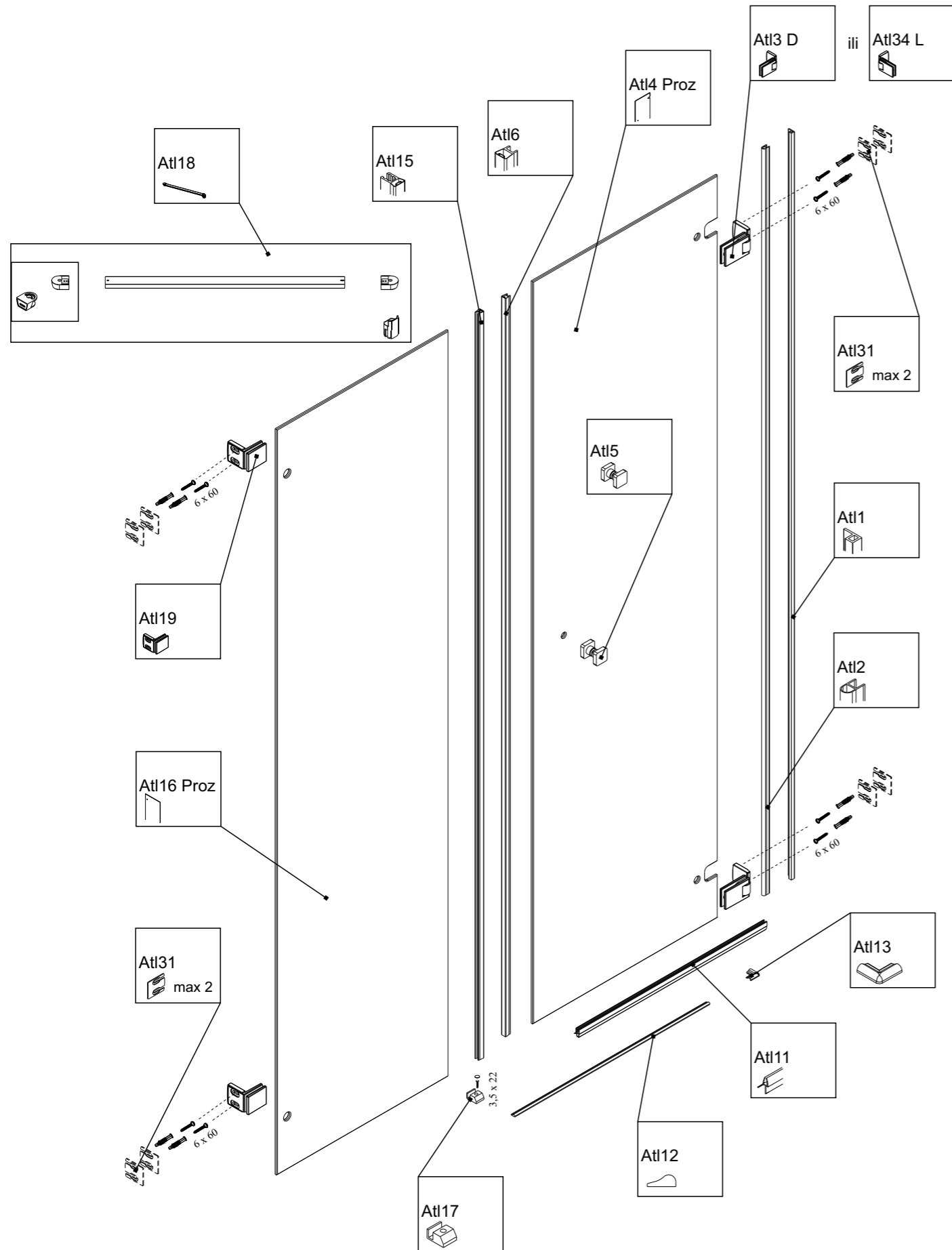



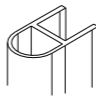
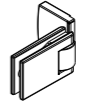
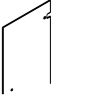
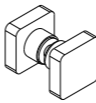

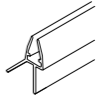
- | | | | |
|--|--|--|---|
| <p>Atl13</p>  <p>x1</p> | <p>Atl17</p>  <p>x1</p> | <p>Atl19</p>  <p>x2</p> | <p>Atl24 Proz</p>  <p>x1</p> |
| <p>Atl25</p>  <p>x1</p> | <p>Atl31</p>  <p>x2</p> | <p>Atl33</p>  <p>x1</p> | |
| <p>Atl26</p>  <p>1 x 4x 4x</p> | | | |

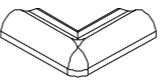

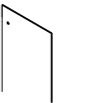

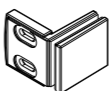

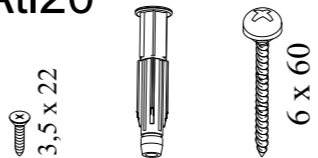

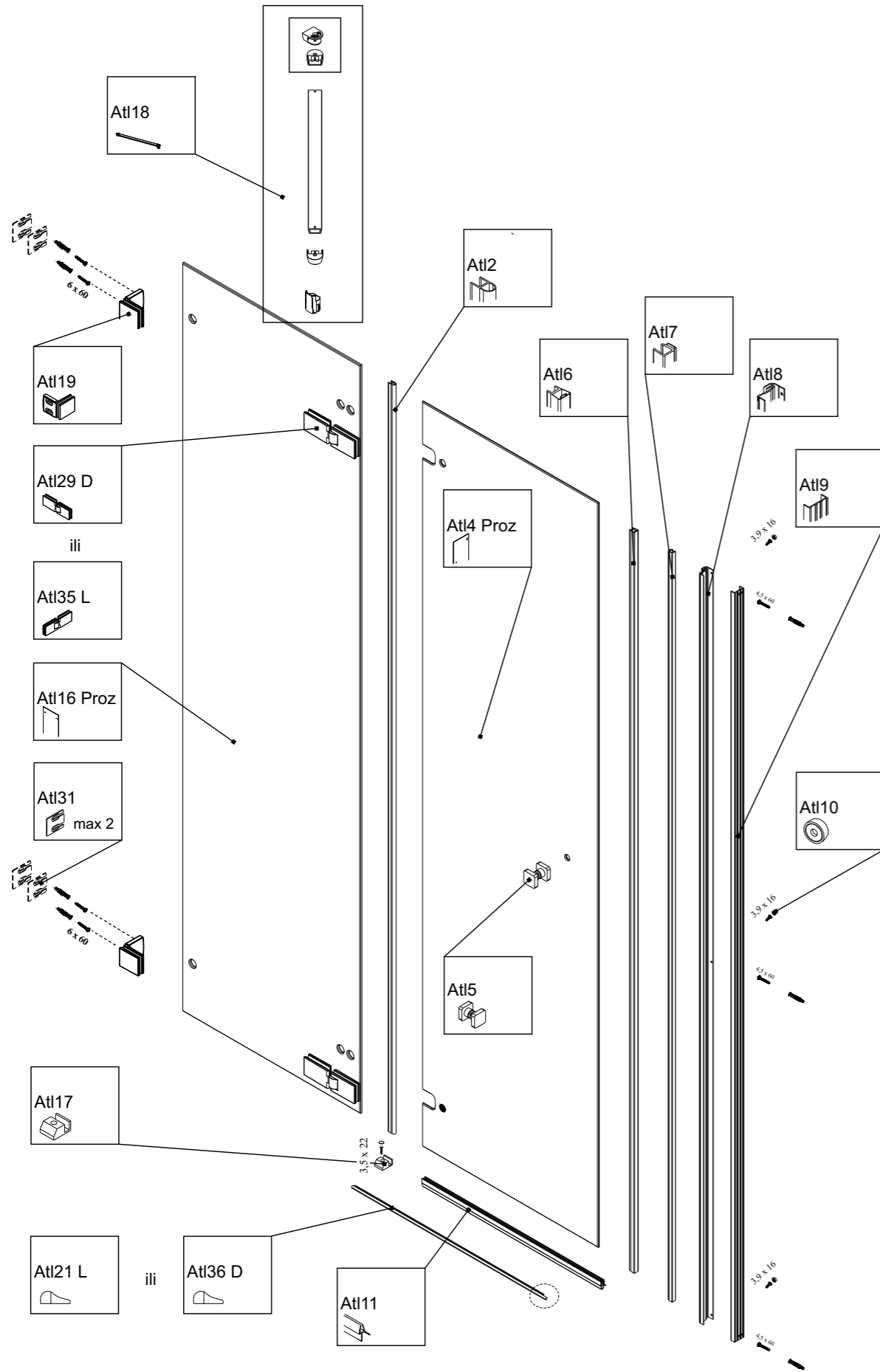



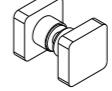

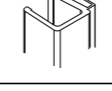



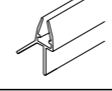

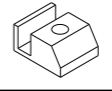

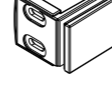

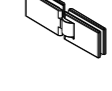

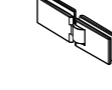













At1  x1	At2  x1	At3 D  x2	At4 Proz  x1
At5  x1	At6  x1	At7  x1	At8  x1
At9  x1	At10  x3	At11  x1	At12  x1
At13  x1	At31  x2	At34 L  x2	
At14  3,9 x 16  4,5 x 60  6 x 60 3x 3x 7x 4x			









Atl1  x1	Atl2  x1	Atl3 D  x2	Atl4 Proz  x1
Atl5  x1	Atl6  x1	Atl11  x1	Atl12  x1
Atl13  x1	Atl15  x1	Atl16 Proz  x1	Atl17  x1
Atl18  x1	Atl19  x2	Atl31  x4	Atl34 L  x2
Atl20  3,5 x 22 8x 6 x 60 1 x 8x 8x			







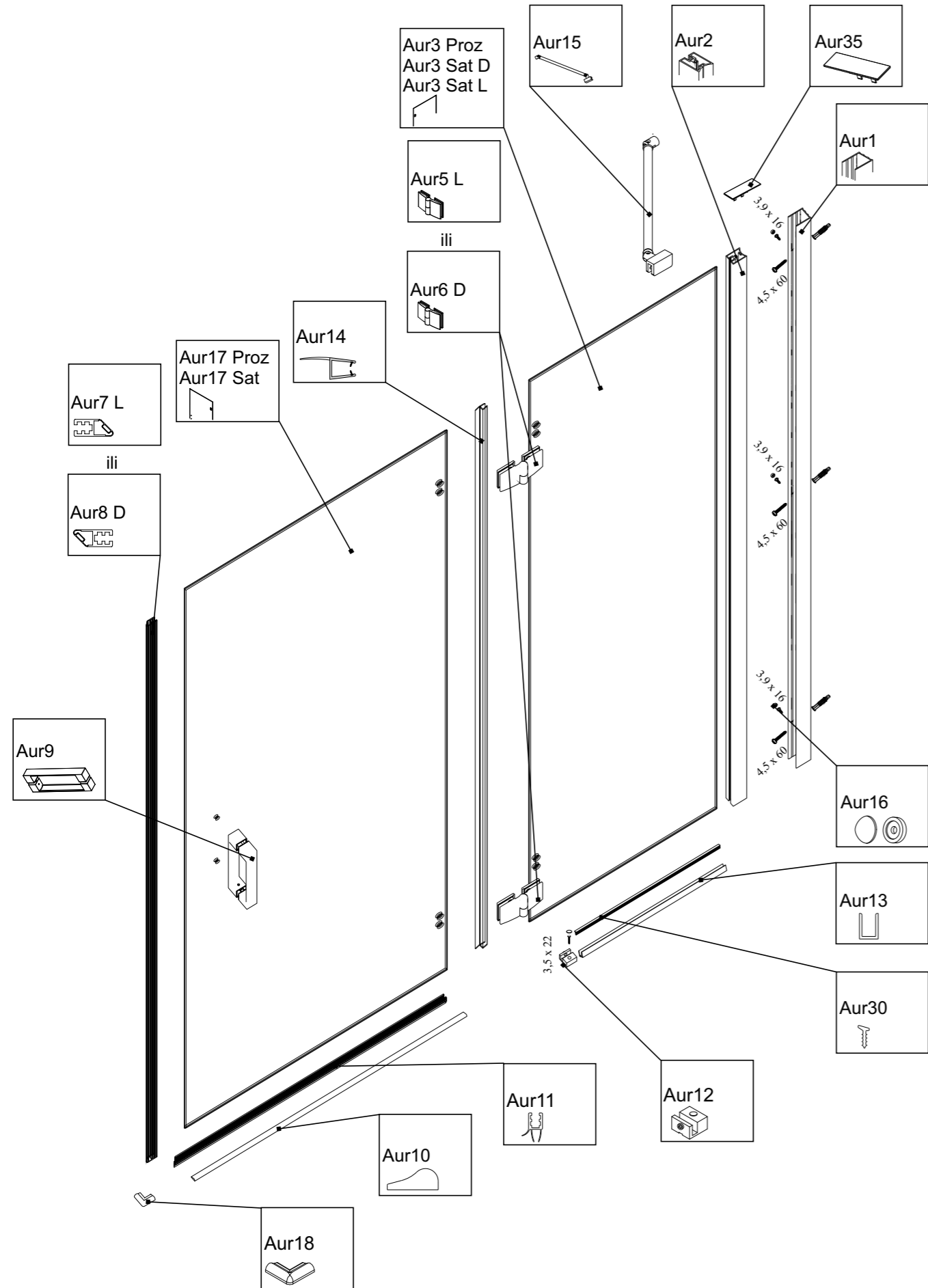

At12  x1	At14 Proz  x1	At15  x1	At16  x1
At17  x1	At18  x1	At19  x1	At110  x3
At111  x1	At116 Proz  x1	At117  x1	At118  x1
At119  x2	At121 L  x1	At129 D  x2	At131  x2
At135 L  x2	At136 D  x1		
At122  3,5 x 22  3,9 x 16  4,5 x 60  6 x 60 1 x 3x 3x 7x 4x			



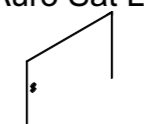
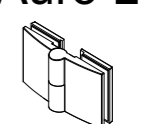
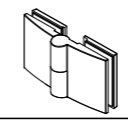
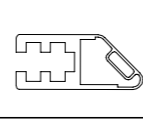
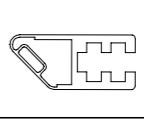
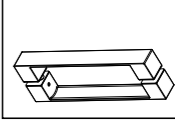
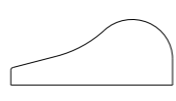
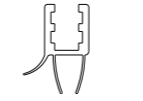
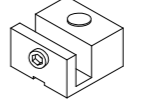
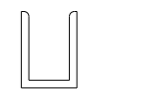

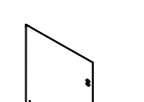
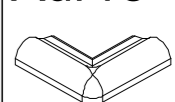

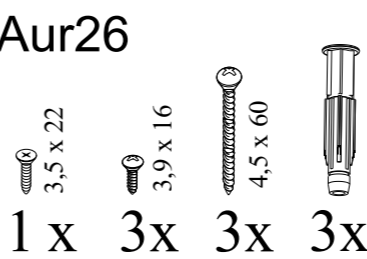

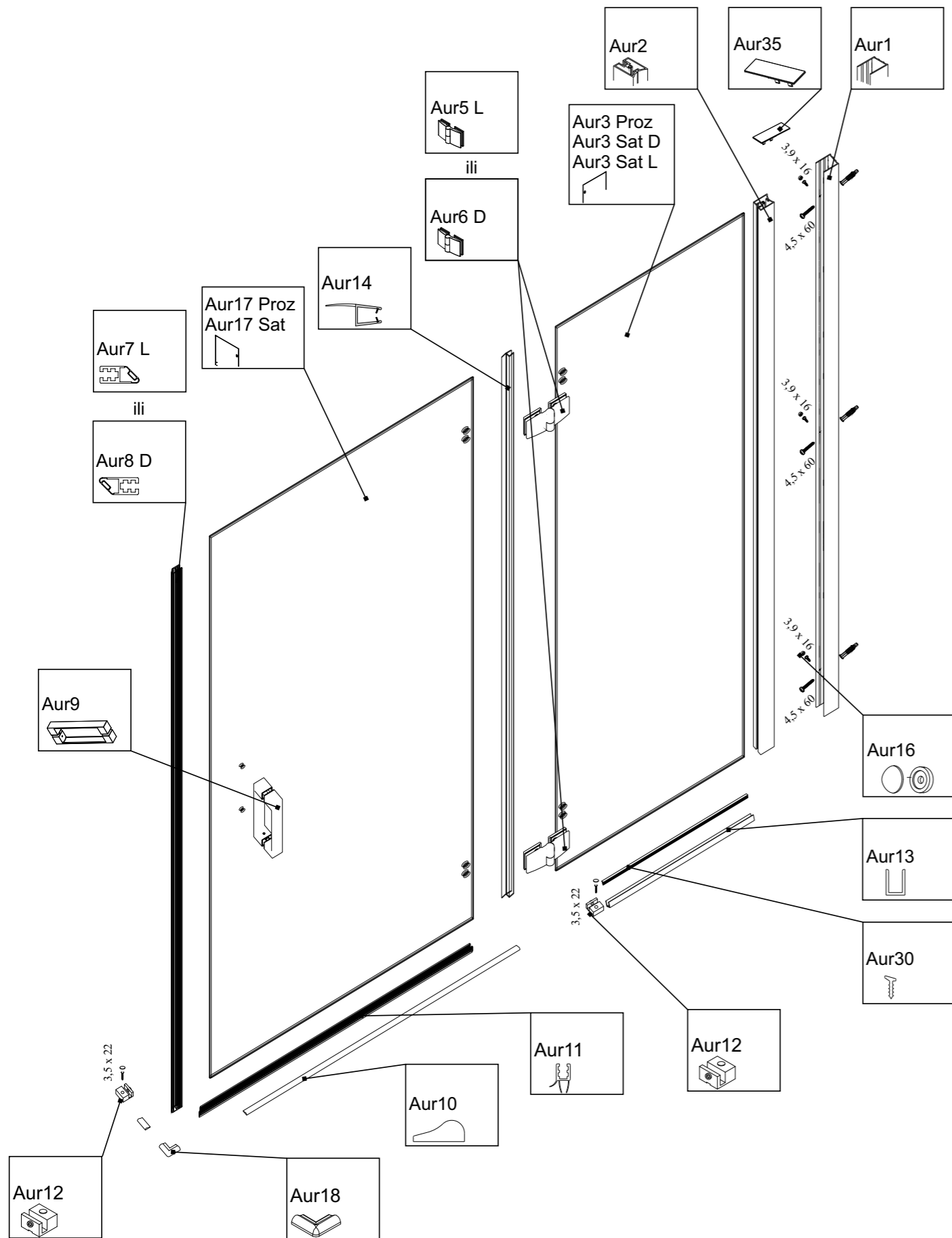

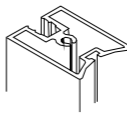
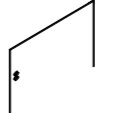
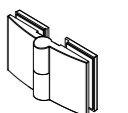
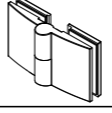
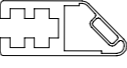
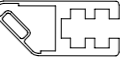

ATLANTIS	Specif. br.	Šifra	Opis
	Atl1	3113082	Zidni brtveni profil Atlantis, L=2200 mm, krom
	Atl2	3112074	PVC profil G 058 V8, L=2200 mm transp
	Atl3 D	3113078	Pant zid-staklo, lift sistem, krom, desni
	Atl34 L	3113077	Pant zid-staklo, lift sistem, krom, lijevi
	Atl5	3113095	Ručka za tuš kabinu Atlantis, kvadratna, krom
	Atl6	3112044	PVC profil mag. M 112 V6 L=2200 mm transp. sivi mag
	Atl7	3112020	PVC profil mag. M 20, V6, L=2200 mm, tr. sivi mag.
	Atl10	3113130	Ukrasna kapica s podloškom, siva
	Atl11	3112016	PVC profil E-504 V6, L=2000 mm azur, za st. 6 mm -TITAN
	Atl12	6100025	Podni brtveni Alu. profil L=1000 mm, silver
	Atl13	3113016	Spojna plastika br. profil, Sigma, kutni
	Atl15 L	3113301	PVC profi mag M 123 L, V8 L=2200 mm, transparent
	Atl35 D	3113300	PVC profi mag M 123 D, V8 L=2200 mm, transparent
	Atl17	3113283	Atlantis donji fiksator, 31x25 mm, inox
	Atl18	3113281	Šipka za fiksiranje 45°, L=500 mm, krom
	Atl19	3113081	Fiksator kutni zid-staklo, krom
	Atl21 L	6100123	Podni brtveni Alu. profil Atlantis L, L=1000 mm, silver
	Atl37 D	6100124	Podni brtveni Alu. profil Atlantis D, L=1000 mm, silver
	Atl23	3112045	PVC profil G 026 V6, L=2400 mm transp, pera 10 mm
	Atl25	6100025	Podni brtveni Alu. profil L=27 mm, silver

ATLANTIS	Specif. br.	Šifra	Opis
	Atl27	3113280	Šipka za fiksiranje 90°, L=1000 mm, krom
	Atl29 D	3113080	Pant staklo-staklo, lift sistem, krom, desni
	Atl36 L	3113079	Pant staklo-staklo, lift sistem, krom, lijevi
	Atl30	3113279	Šipka za fiksiranje T-spoj, L=1200 mm, krom
		3113278	Šipka za fiksiranje T-spoj, L=1600 mm, krom
		3113284	Šipka za fiksiranje T-spoj, L=2000 mm, krom
	Atl31	3113083	Podložna pločica za pant zid-staklo, transparent
	Atl33	3112021	PVC profil mag. M 20, V8, L=2200 mm, tr. sivi mag.

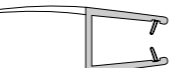

- | | | | |
|---|---|--|--|
|  Aur1
x1 |  Aur2
x1 |  Aur3 Proz
Aur3 Sat D
Aur3 Sat L
x1 |  Aur5 L
x2 |
|  Aur6 D
x2 |  Aur7 L
x1 |  Aur8 D
x1 |  Aur9
x1 |
|  Aur10
x1 |  Aur11
x1 |  Aur12
x1 |  Aur13
x1 |
|  Aur14
x1 |  Aur 16
x3 |  Aur17 Proz
Aur17 Sat
x1 |  Aur18
x1 |
|  Aur30
x1 |  Aur35
x1 | | |
|  Aur26
3,5 x 22 1 x
3,9 x 16 3 x
4,5 x 60 3 x
3 x | | | |



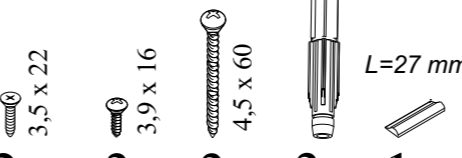

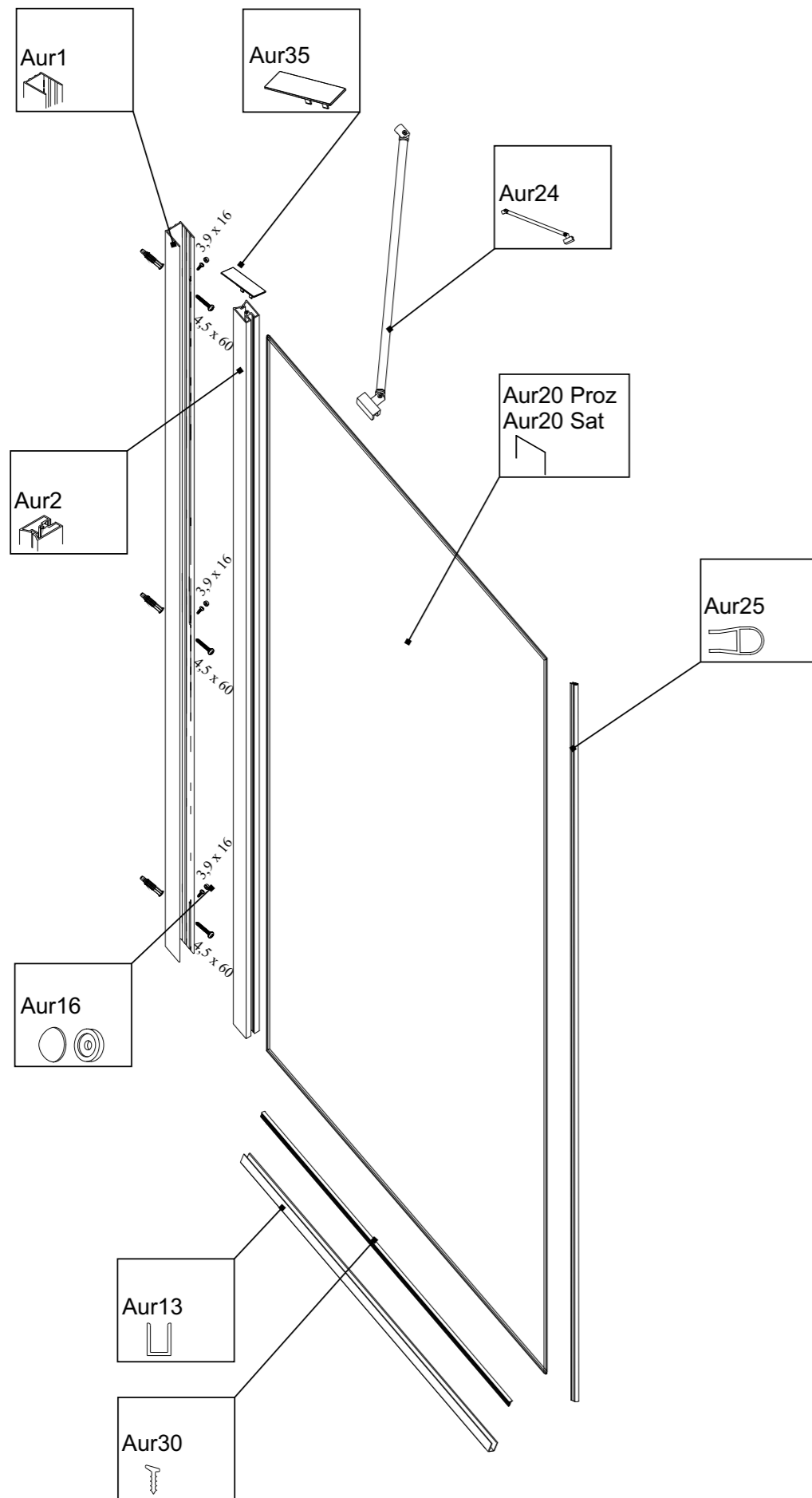



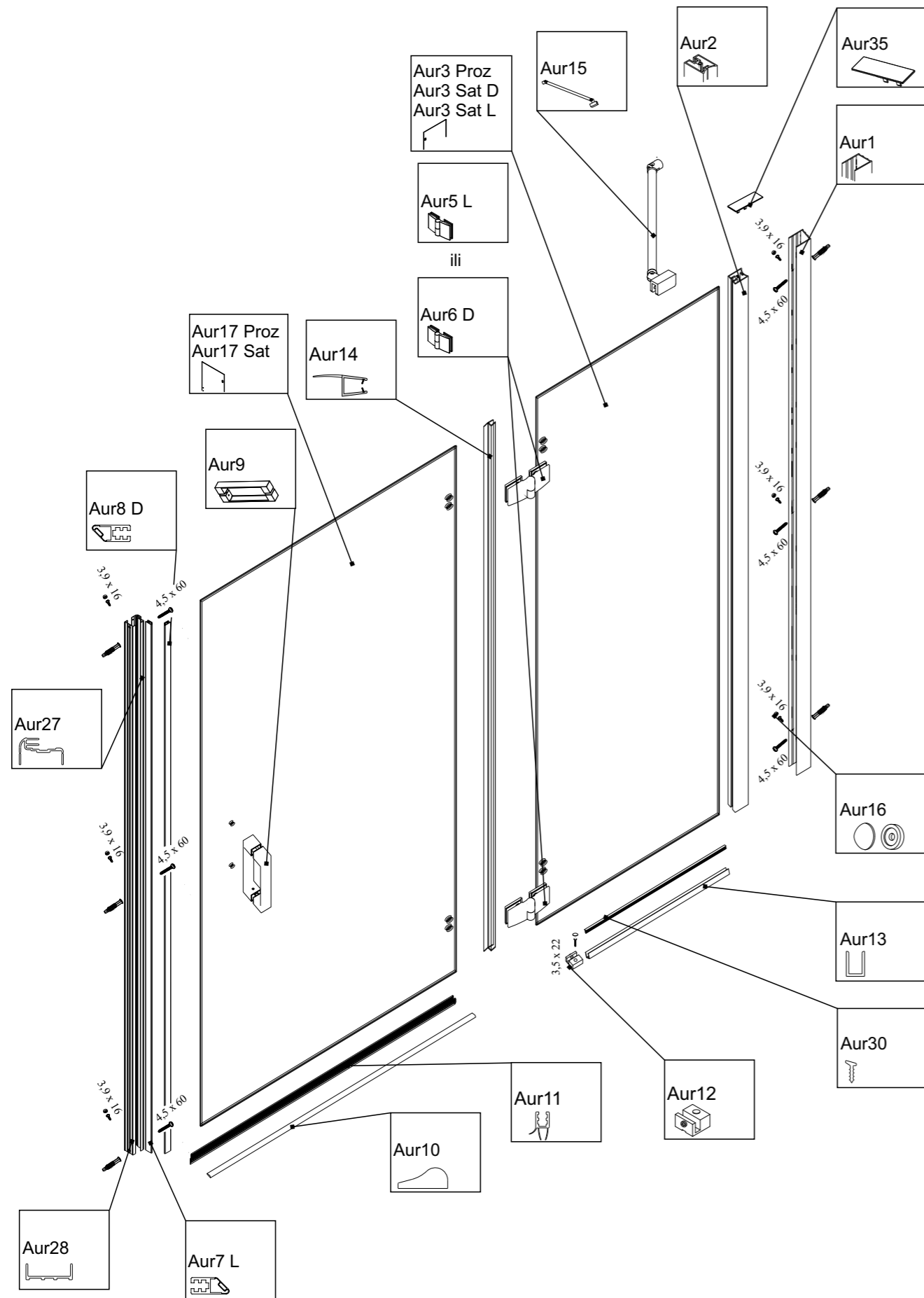

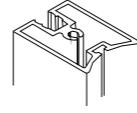
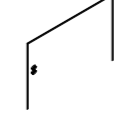
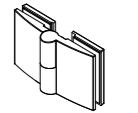
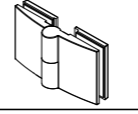
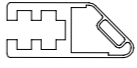
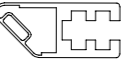

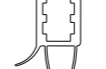
Aur1  x1	Aur2  x1	Aur3 Proz Aur3 Sat D Aur3 Sat L  x1	Aur5 L  x2
Aur6 D  x2	Aur7 L  x1	Aur8 D  x1	Aur9  x1
Aur10  x1	Aur11  x1	Aur12  x2	Aur13  x1
Aur14  x1	Aur 16  x3	Aur17 Proz Aur17 Sat  x1	Aur18  x1
Aur30  x1	Aur35  x1		
Aur19  3,5 x 22 3,9 x 16 4,5 x 60 L=27 mm 2 x 3 x 3 x 3 x 1 x			

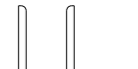

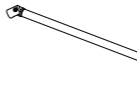

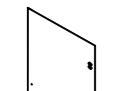
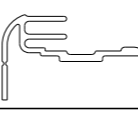

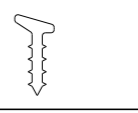
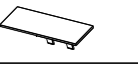
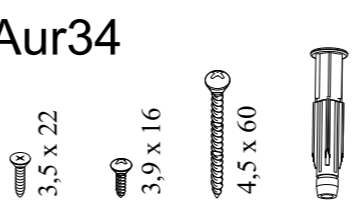
- | | | | |
|---|------------------------|------------------------|-------------------------|
| <p>Aur1</p> <p>x1</p> | <p>Aur2</p> <p>x1</p> | <p>Aur13</p> <p>x1</p> | <p>Aur 16</p> <p>x3</p> |
| <p>Aur20 Proz
Aur20 Sat</p> <p>x1</p> | <p>Aur24</p> <p>x1</p> | <p>Aur25</p> <p>x1</p> | <p>Aur30</p> <p>x1</p> |
| <p>Aur35</p> <p>x1</p> | | | |
| <p>Aur23</p> <p>3x 3x 3x</p> | | | |

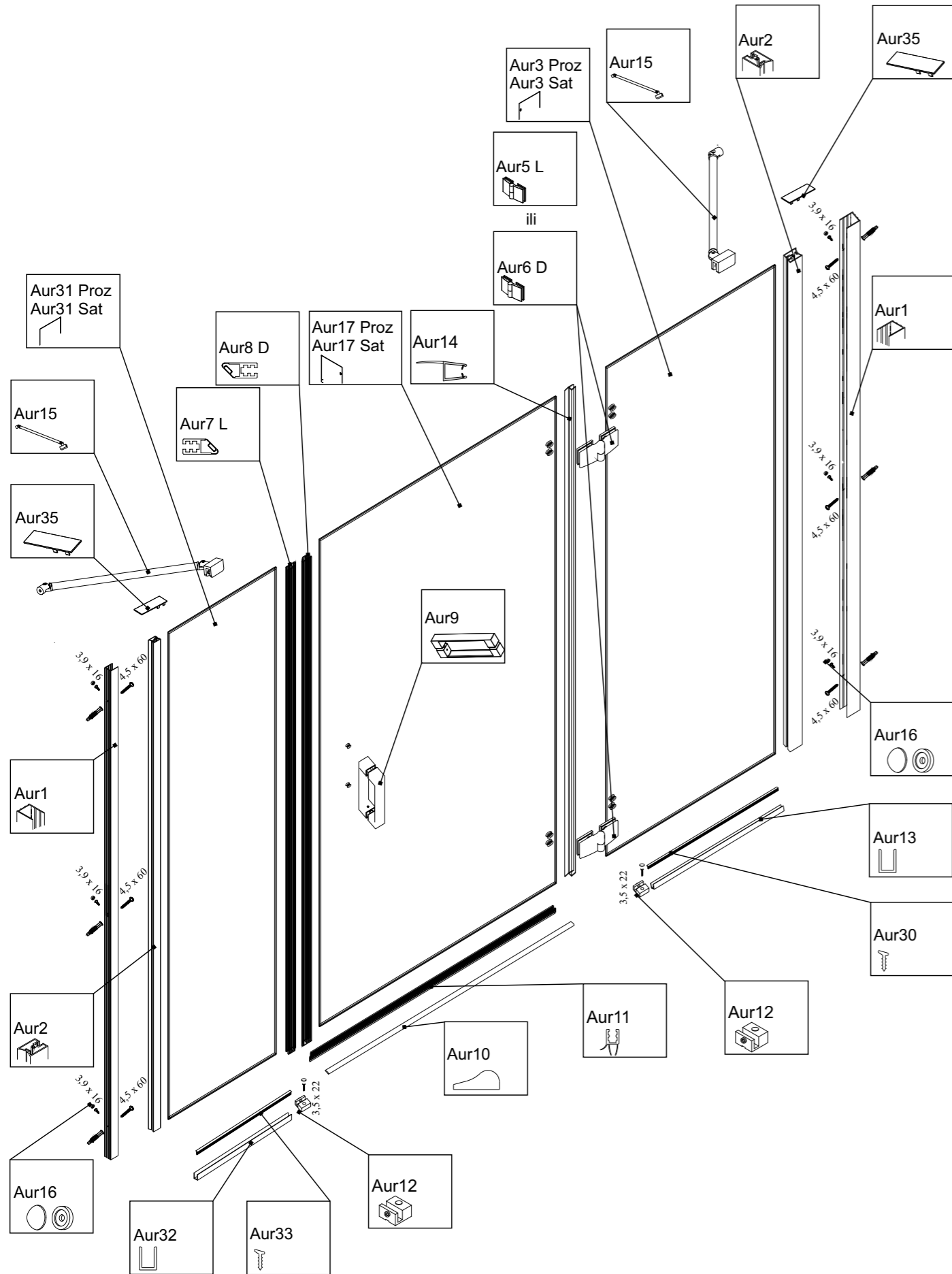

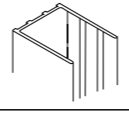
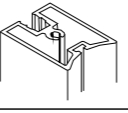
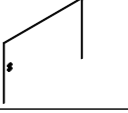
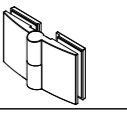
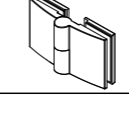
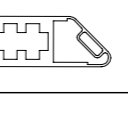
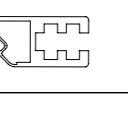
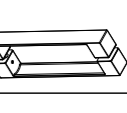
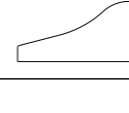
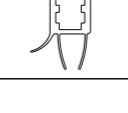
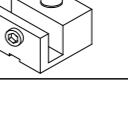
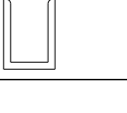
 Aur1 x1	 Aur2 x1	 Aur3 Proz Aur3 Sat D Aur3 Sat L x1	 Aur5 L x2
 Aur6 D x2	 Aur7 L x1	 Aur8 D x1	 Aur9 x1
 Aur10 x1	 Aur11 x1	 Aur12 x1	 Aur13 x1
 Aur14 x1	 Aur15 x1	 Aur16 x6	 Aur17 Proz Aur17 Sat x1
 Aur27 x1	 Aur28 x1	 Aur30 x1	 Aur35 x1
 Aur34 3,5 x 22 3,9 x 16 4,5 x 60 1 x 6x 6x 6x			

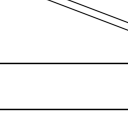
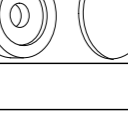
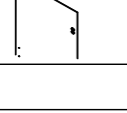
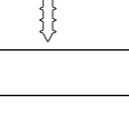
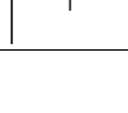

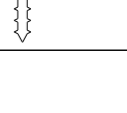
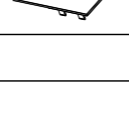
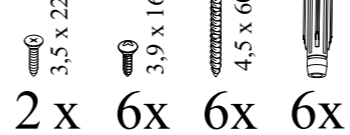

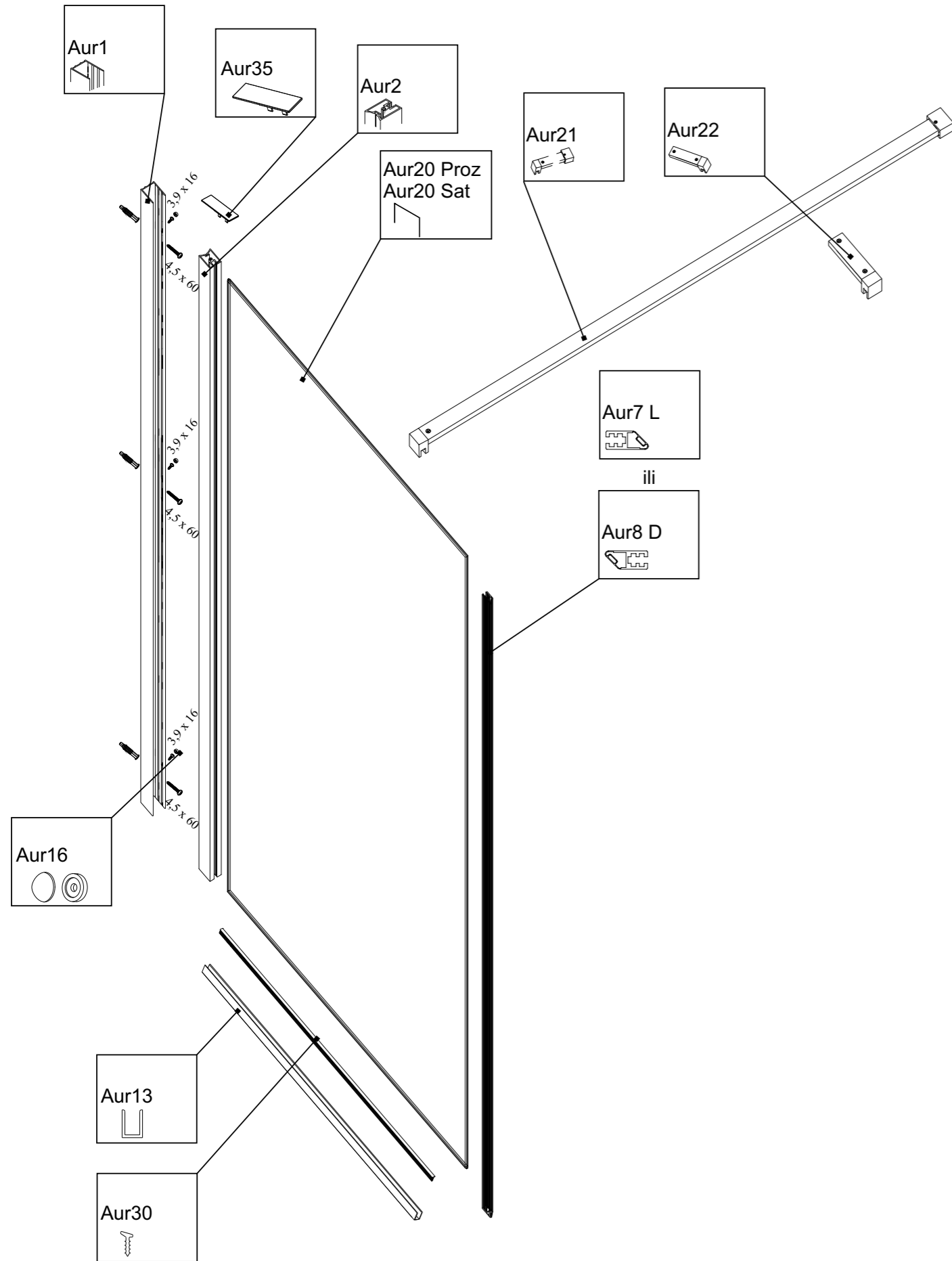



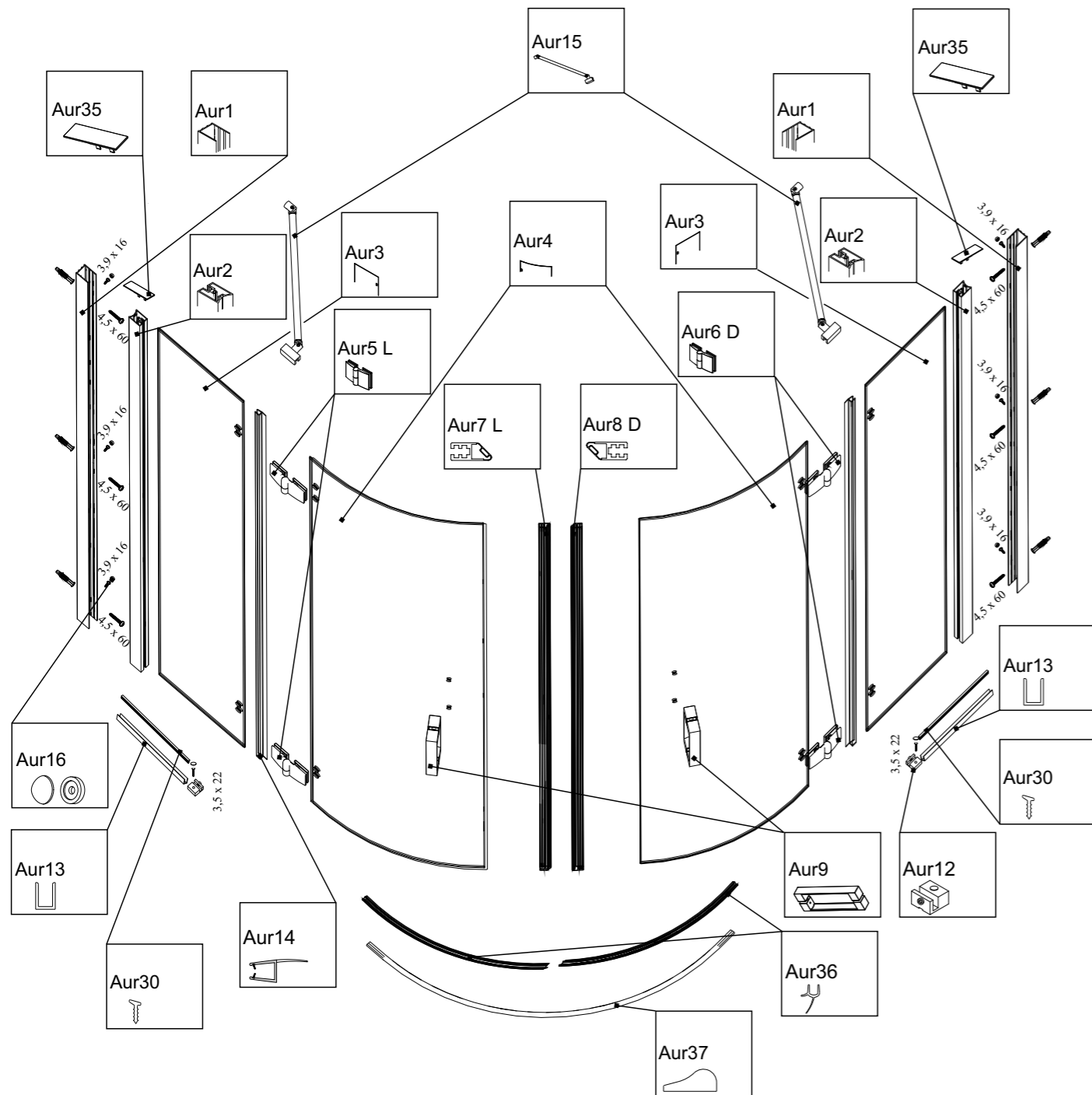

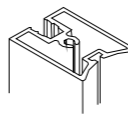
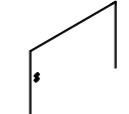
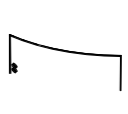
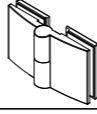
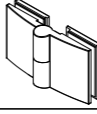

<p>Aur1</p>  <p>x2</p>	<p>Aur2</p>  <p>x2</p>	<p>Aur3 Proz Aur3 Sat</p>  <p>x1</p>	<p>Aur5 L</p>  <p>x2</p>
<p>Aur6 D</p>  <p>x2</p>	<p>Aur7 L</p>  <p>x1</p>	<p>Aur8 D</p>  <p>x1</p>	<p>Aur9</p>  <p>x1</p>
<p>Aur10</p>  <p>x1</p>	<p>Aur11</p>  <p>x1</p>	<p>Aur12</p>  <p>x2</p>	<p>Aur13</p>  <p>x1</p>
<p>Aur14</p>  <p>x1</p>	<p>Aur15</p>  <p>x2</p>	<p>Aur16</p>  <p>x6</p>	<p>Aur17 Proz Aur17 Sat</p>  <p>x1</p>
<p>Aur30</p>  <p>x1</p>	<p>Aur31 Proz Aur31 Sat</p>  <p>x1</p>	<p>Aur32</p>  <p>x1</p>	<p>Aur33</p>  <p>x1</p>
<p>Aur35</p>  <p>x2</p>			
<p>Aur29</p>  <p>2 x 3,5 x 22 6 x 3,9 x 16 6 x 4,5 x 60</p>			

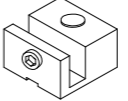

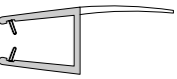
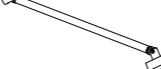
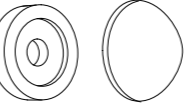



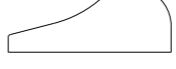
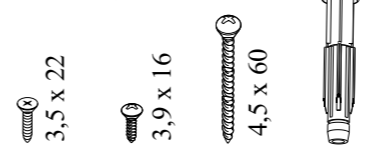













- | | | | |
|---|-----------------------------|--|-----------------------------|
| <p>Aur1
x1</p> | <p>Aur2
x1</p> | <p>Aur7 L
x1</p> | <p>Aur8 D
x1</p> |
| <p>Aur13
x1</p> | <p>Aur 16
x3</p> | <p>Aur20 Proz
Aur20 Sat
x1</p> | <p>Aur21
x1</p> |
| <p>Aur22
x1</p> | <p>Aur30
x1</p> | <p>Aur35
x1</p> | |
| <p>Aur23</p> <p> 3,9 x 16
 4,5 x 60
 </p> <p>3x 3x 3x</p> | | | |











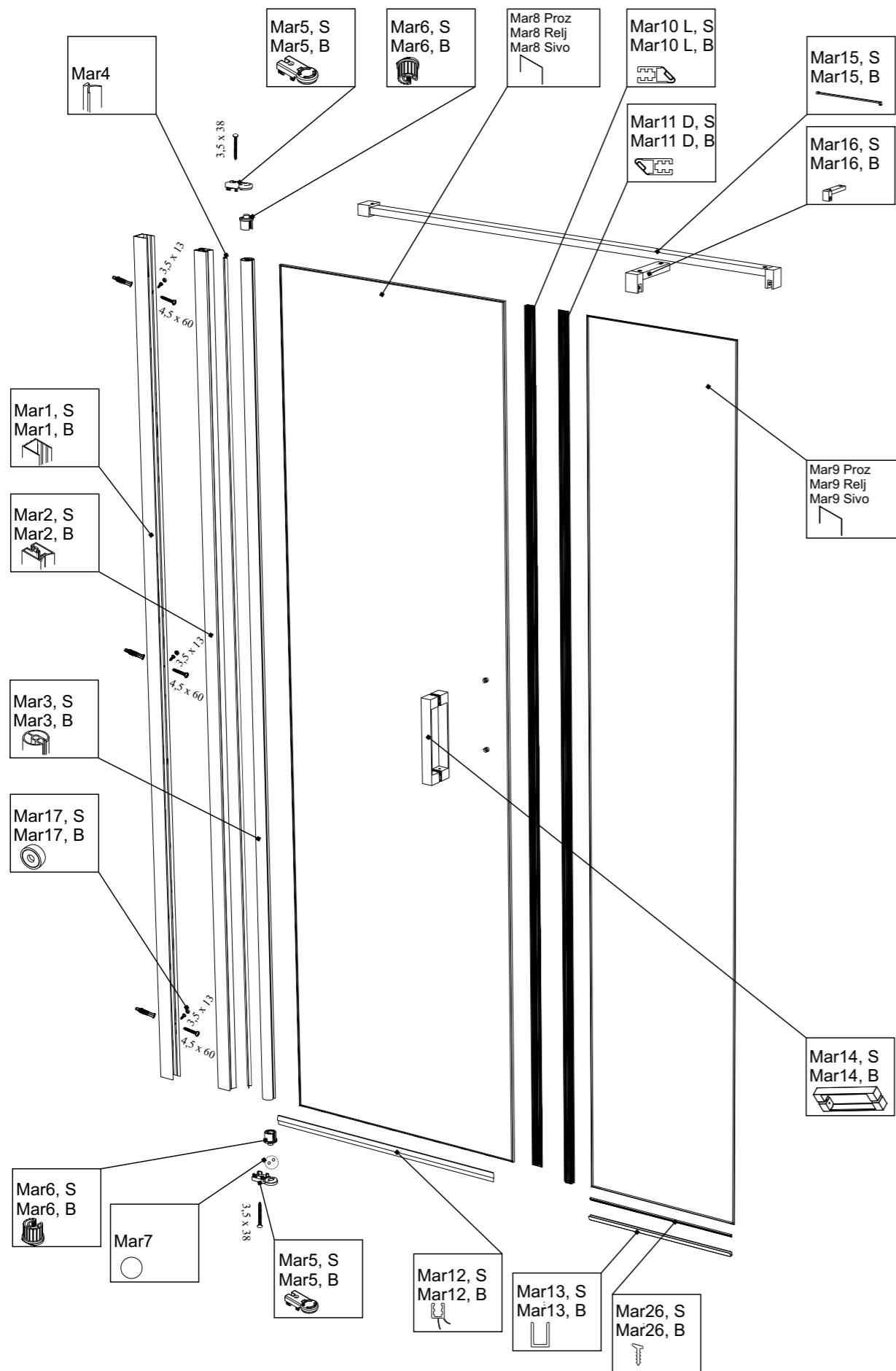

- | | | | |
|---|--|---|---|
| Aur1
 x2 | Aur2
 x2 | Aur3
 x2 | Aur4
 x2 |
| Aur5 L
 x2 | Aur6 D
 x2 | Aur7 L
 x1 | Aur8 D
 x1 |
| Aur9
 x2 | Aur12
 x2 | Aur13
 x2 | Aur14
 x2 |
| Aur15
 x2 | Aur 16
 x6 | Aur30
 x2 | Aur35
 x2 |
| Aur36
 x2 | Aur37
 x1 | | |
| Aur29

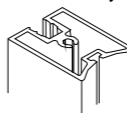
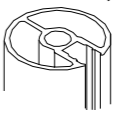
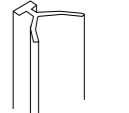
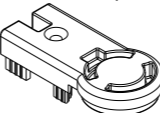
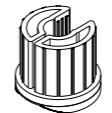
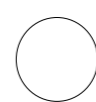
3,5 x 22 3,9 x 16 4,5 x 60
2 x 6x 6x 6x | | | |

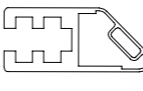
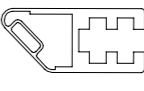

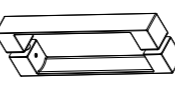

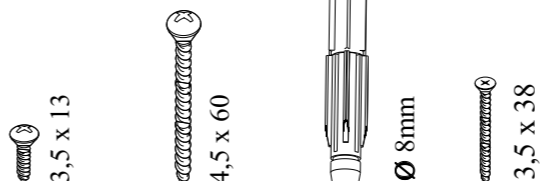

AURORA D + D

AURORA	Specif. br.	Šifra	Opis
	Aur5 L	3113028	Metalni pant s lift sist. KOCER L
	Aur6 D	3113027	Metalni pant s lift sist. KOCER D
	Aur7 L	3112083	PVC profil mag. M 126 L, V6 L=2000 mm, transp. sivi mag
	Aur8 D	3112084	PVC profil mag. M 126 D, V6 L=2000 mm, transp. sivi mag
	Aur9	3113054	Ručke za tuš kabinu cod. 1015 – chrom, par
	Aur10	6100025	Podni brtveni alu. profil L=1000 mm, silver
	Aur11	3112045	PVC profil G 026 V6, L=2400 mm transp, pera 10 mm
	Aur12	3113045	Aurora donji fiksator, 25x25 mm, inox
	Aur13 Aur32	6100035	Alu. profil U 15x11x15, L=1000 mm, silver
	Aur14	3112071	PVC profil G 046 V6, L=1985 mm transp, za staklo 6 mm
	Aur15	3113029	Metalna šipka za kutno fiksiranje, 40 cm, chrom
	Aur24	3113037	Metalna šipka za kutno fiksiranje, 69 cm, chrom
	Aur16	3113130	Ukrasna kapica s podloškom, siva
	Aur18	3113016	Spojna plastika br. profil, Sigma, kutni
	Aur21	3113034	Šipka za fiksiranje L=1990 mm kvadratna, brill
	Aur21	3113031	Šipka za fiksiranje L=1490 mm kvadratna, brill
	Aur21	3113033	Šipka za fiksiranje L=990 mm kvadratna, brill
	Aur22	3113032	Šipka za fiksiranje L=100 mm kvadratna, brill
	Aur25	3112037	PVC profil G 052 V6-8mm, L=2020 mm azurna, s mjehurom
	Aur30 Aur33	3112024	PVC profil F60/2 vertikalni za profil E-8854,prozi, L=1000 mm
	Aur35	3113207	Poklopac za zid. prof. Oasis, Mars, Aurora - sivi
	Aur36	3112060	PVC profil 911/12, V6, L=2000 mm azurna
	Aur37	6100202	Podni brtveni luk alu. profil, L=1000mm, silver

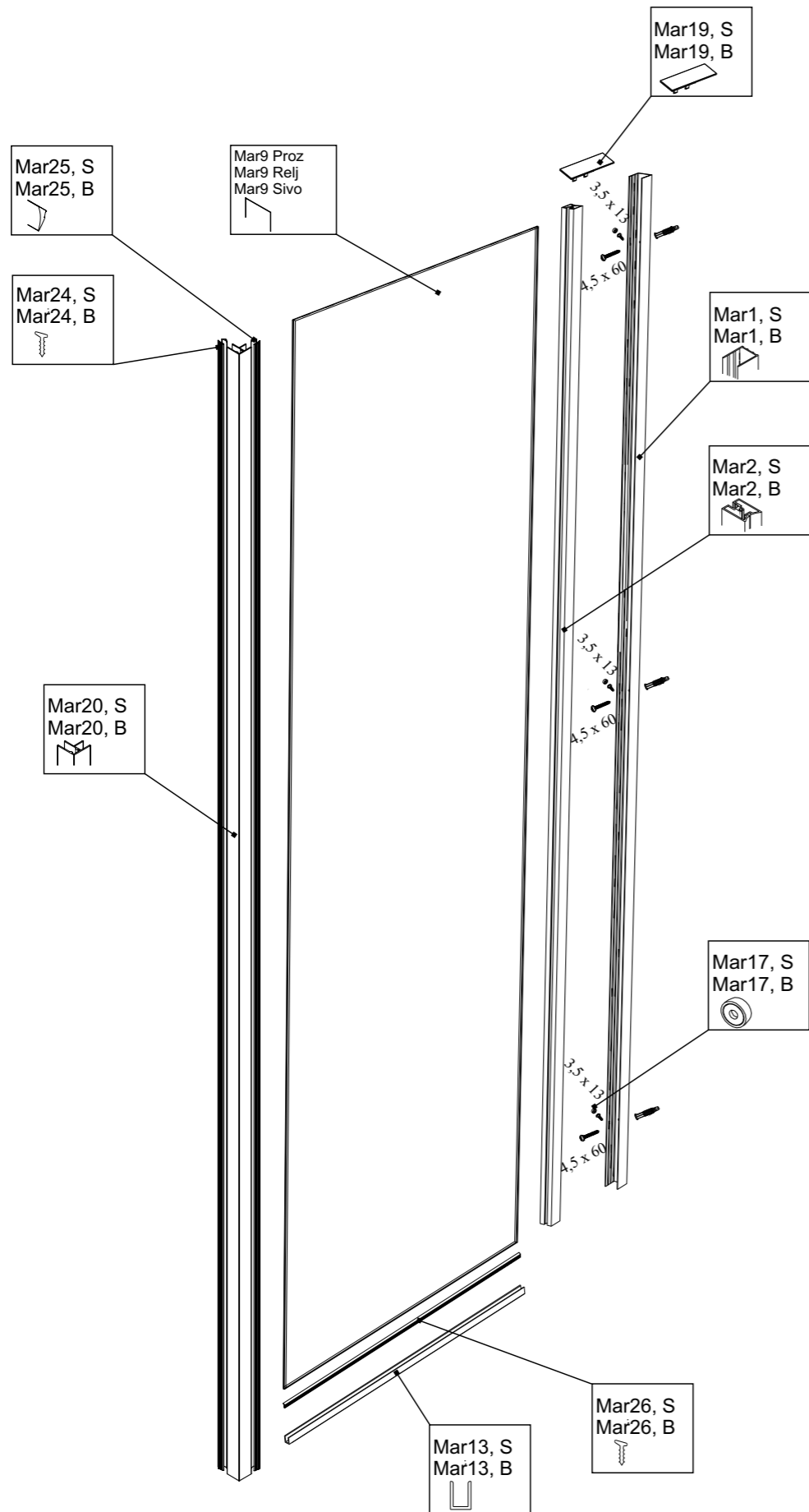

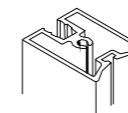
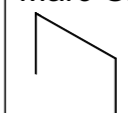
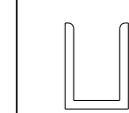

- | | | | |
|---|--|--|--|
| <p>Mar1, S
Mar1, B</p>  <p>x1</p> | <p>Mar2, S
Mar2, B</p>  <p>x1</p> | <p>Mar3, S
Mar3, B</p>  <p>x1</p> | <p>Mar4</p>  <p>x1</p> |
| <p>Mar5, S
Mar5, B</p>  <p>x2</p> | <p>Mar6, S
Mar6, B</p>  <p>x2</p> | <p>Mar7</p>  <p>x2</p> | <p>Mar8 Proz
Mar8 Relj
Mar8 Sivo</p>  <p>x1</p> |
| <p>Mar9 Proz
Mar9 Relj
Mar9 Sivo</p>  <p>x1</p> | <p>Mar10 L, S
Mar10 L, B</p>  <p>x1</p> | <p>Mar11 D, S
Mar11 D, B</p>  <p>x1</p> | <p>Mar12, S
Mar12, B</p>  <p>x1</p> |
| <p>Mar13, S
Mar13, B</p>  <p>x1</p> | <p>Mar14, S
Mar14, B</p>  <p>x1</p> | <p>Mar15, S
Mar15, B</p>  <p>x1</p> | <p>Mar16, S
Mar16, B</p>  <p>x1</p> |
| <p>Mar17, S
Mar17, B</p>  <p>x3</p> | <p>Mar26, S
Mar26, B</p>  <p>x1</p> | | |
| <p>Mar18</p> <p>3x 3x 3x 2x</p>  <p>3,5 x 13 4,5 x 60 Ø 8mm 3,5 x 38</p> | | | |

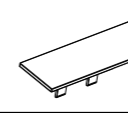
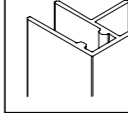
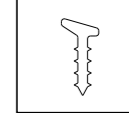
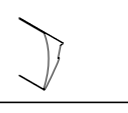
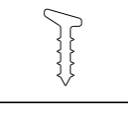
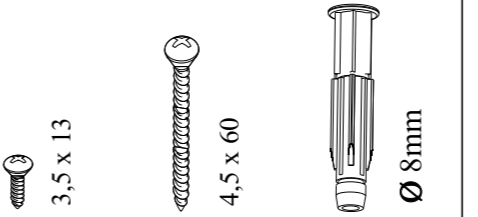

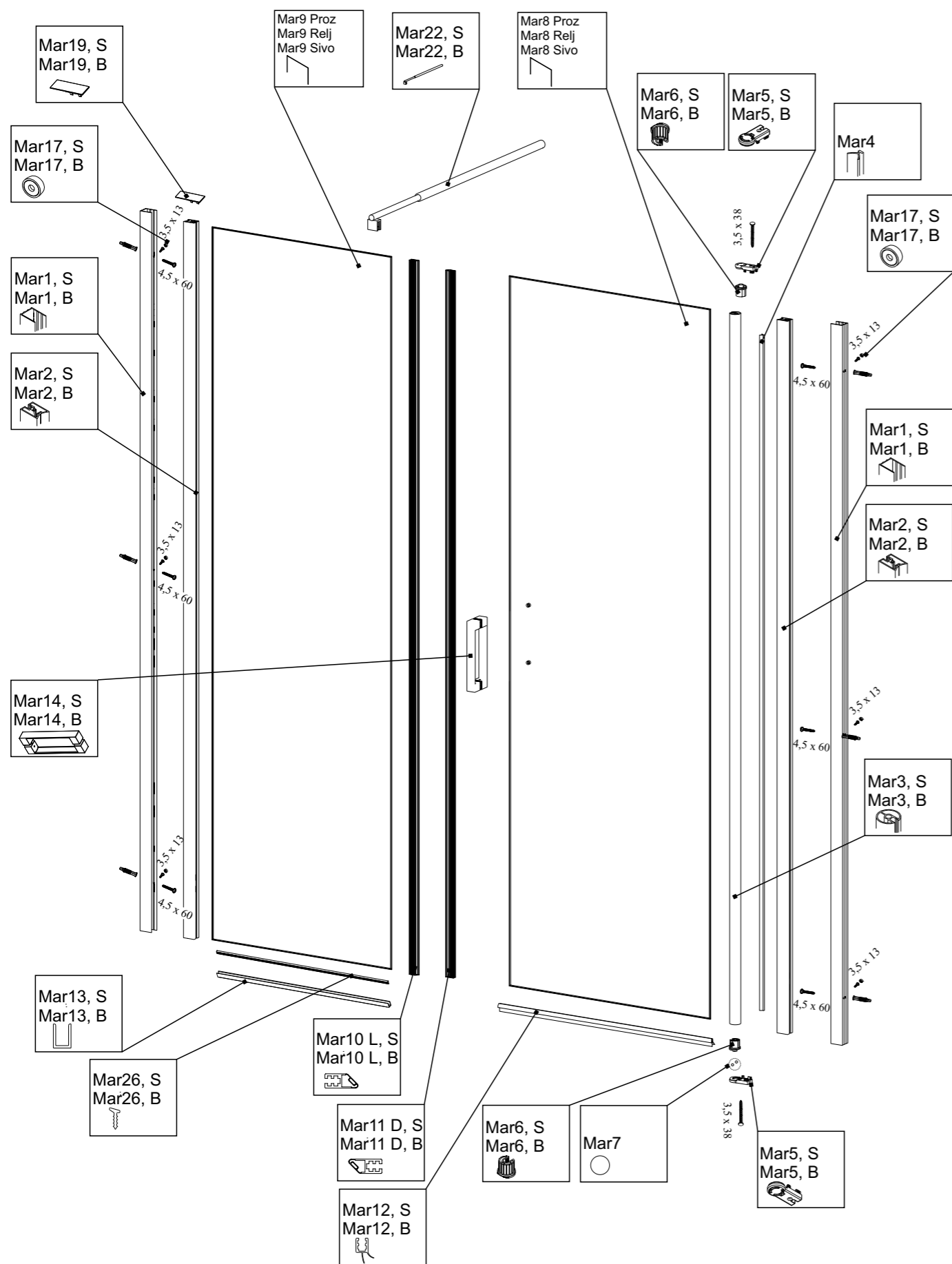

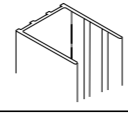
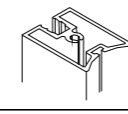
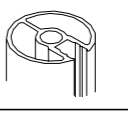
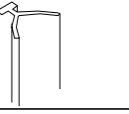
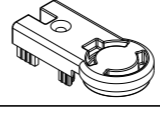
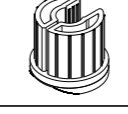
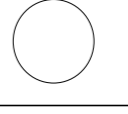
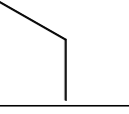

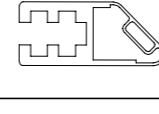
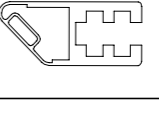
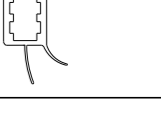
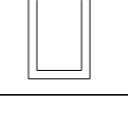
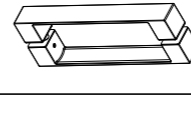
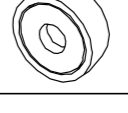
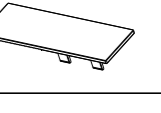
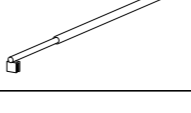
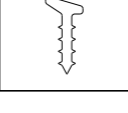
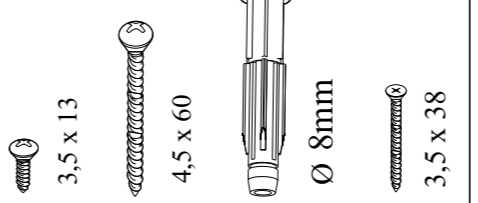

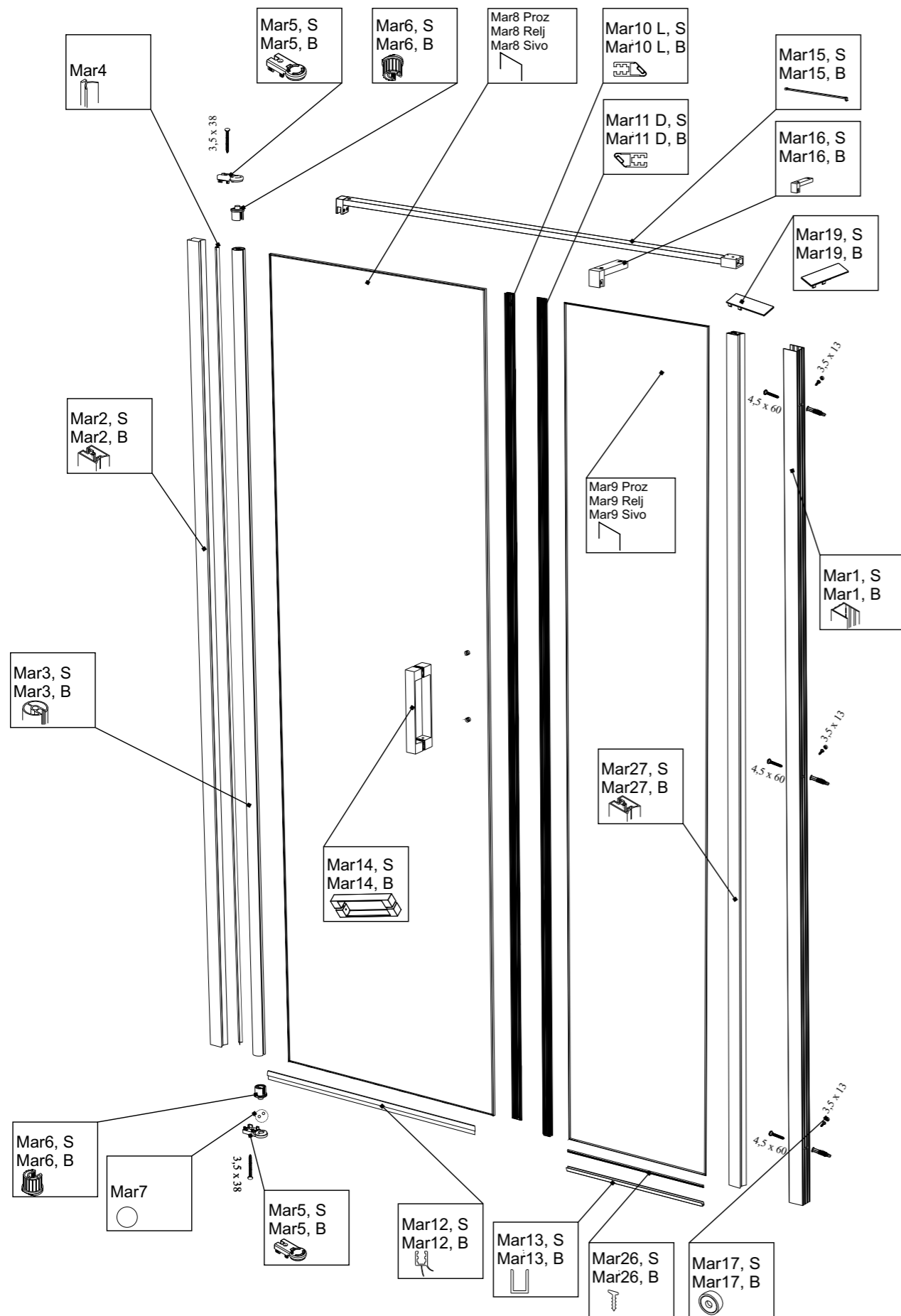

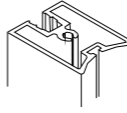
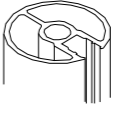
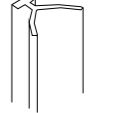
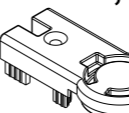
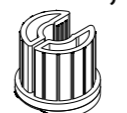
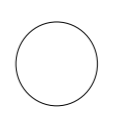
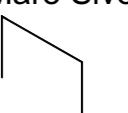

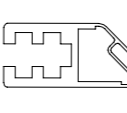
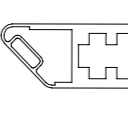
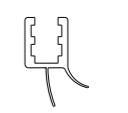
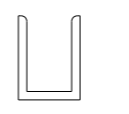
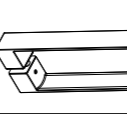
- | | | | |
|---|---|--|--|
| <p>Mar1, S
Mar1, B</p>  <p>x1</p> | <p>Mar2, S
Mar2, B</p>  <p>x1</p> | <p>Mar9 Proz
Mar9 Relj
Mar9 Sivo</p>  <p>x1</p> | <p>Mar13, S
Mar13, B</p>  <p>x1</p> |
| <p>Mar17, S
Mar17, B</p>  <p>x3</p> | <p>Mar19, S
Mar19, B</p>  <p>x1</p> | <p>Mar20, S
Mar20, B</p>  <p>x1</p> | <p>Mar24, S
Mar24, B</p>  <p>x2</p> |
| <p>Mar25, S
Mar25, B</p>  <p>x2</p> | <p>Mar26, S
Mar26, B</p>  <p>x1</p> | | |
| <p>Mar21</p> <p>3x 3x 3x</p>  <p>3,5 x 13 4,5 x 60 Ø 8mm</p> | | | |

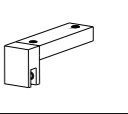

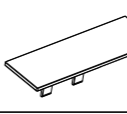
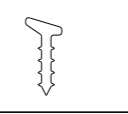
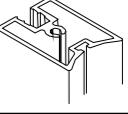

- | | | | |
|---|--|--|--|
| <p>Mar1, S
Mar1, B</p>  <p>x2</p> | <p>Mar2, S
Mar2, B</p>  <p>x2</p> | <p>Mar3, S
Mar3, B</p>  <p>x1</p> | <p>Mar4</p>  <p>x1</p> |
| <p>Mar5, S
Mar5, B</p>  <p>x2</p> | <p>Mar6, S
Mar6, B</p>  <p>x2</p> | <p>Mar7</p>  <p>x2</p> | <p>Mar8 Proz
Mar8 Relj
Mar8 Sivo</p>  <p>x1</p> |
| <p>Mar9 Proz
Mar9 Relj
Mar9 Sivo</p>  <p>x1</p> | <p>Mar10 L, S
Mar10 L, B</p>  <p>x1</p> | <p>Mar11 D, S
Mar11 D, B</p>  <p>x1</p> | <p>Mar12, S
Mar12, B</p>  <p>x1</p> |
| <p>Mar13, S
Mar13, B</p>  <p>x1</p> | <p>Mar14, S
Mar14, B</p>  <p>x1</p> | <p>Mar17, S
Mar17, B</p>  <p>x6</p> | <p>Mar19, S
Mar19, B</p>  <p>x1</p> |
| <p>Mar22, S
Mar22, B</p>  <p>x1</p> | <p>Mar26, S
Mar26, B</p>  <p>x1</p> | | |
| <p>Mar23</p> <p>6x 6x 6x 2x</p>  <p>3,5 x 13 4,5 x 60 Ø 8mm 3,5 x 38</p> | | | |

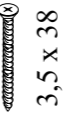

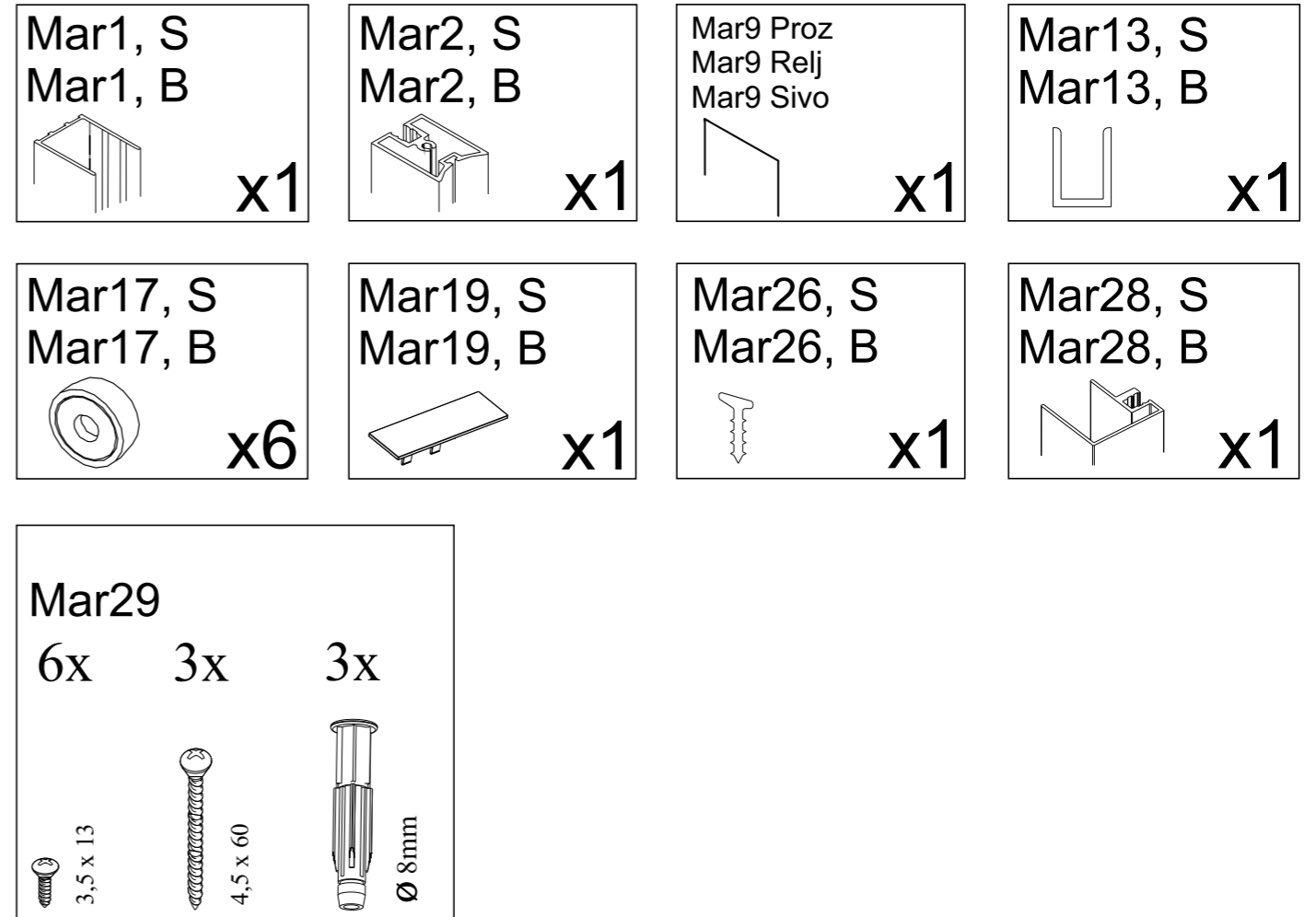
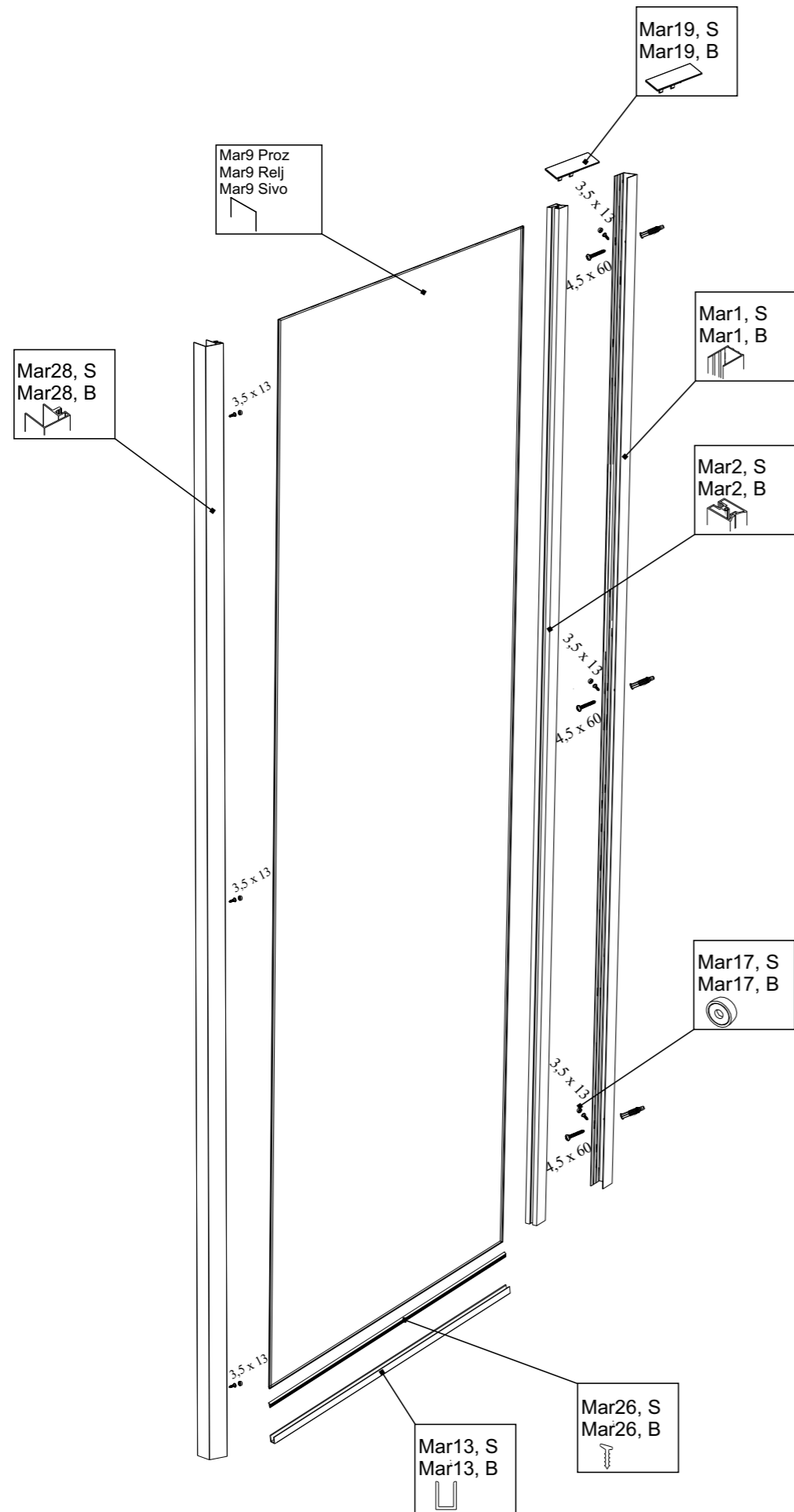

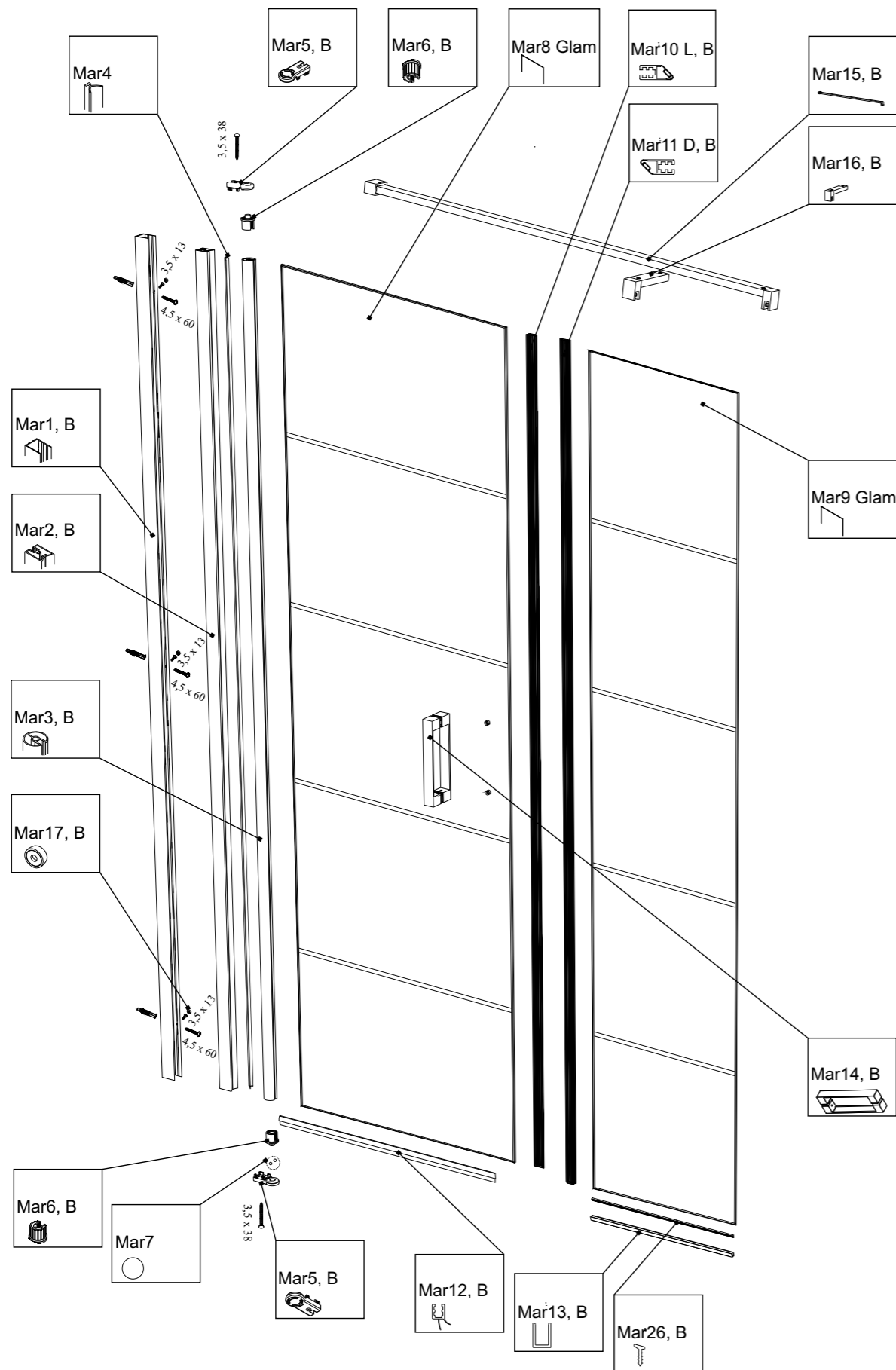

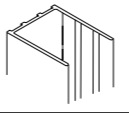
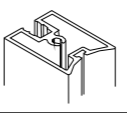
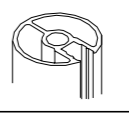
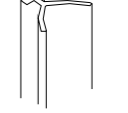
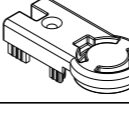
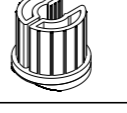
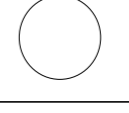
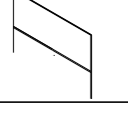
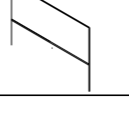
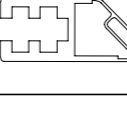
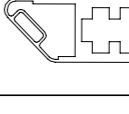
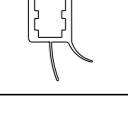
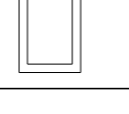
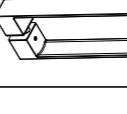
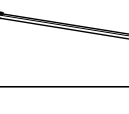
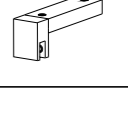

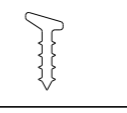
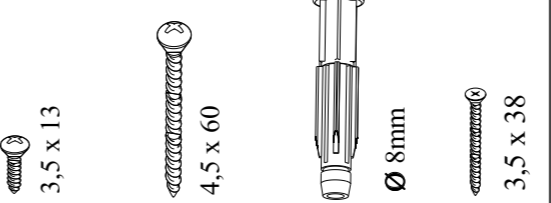

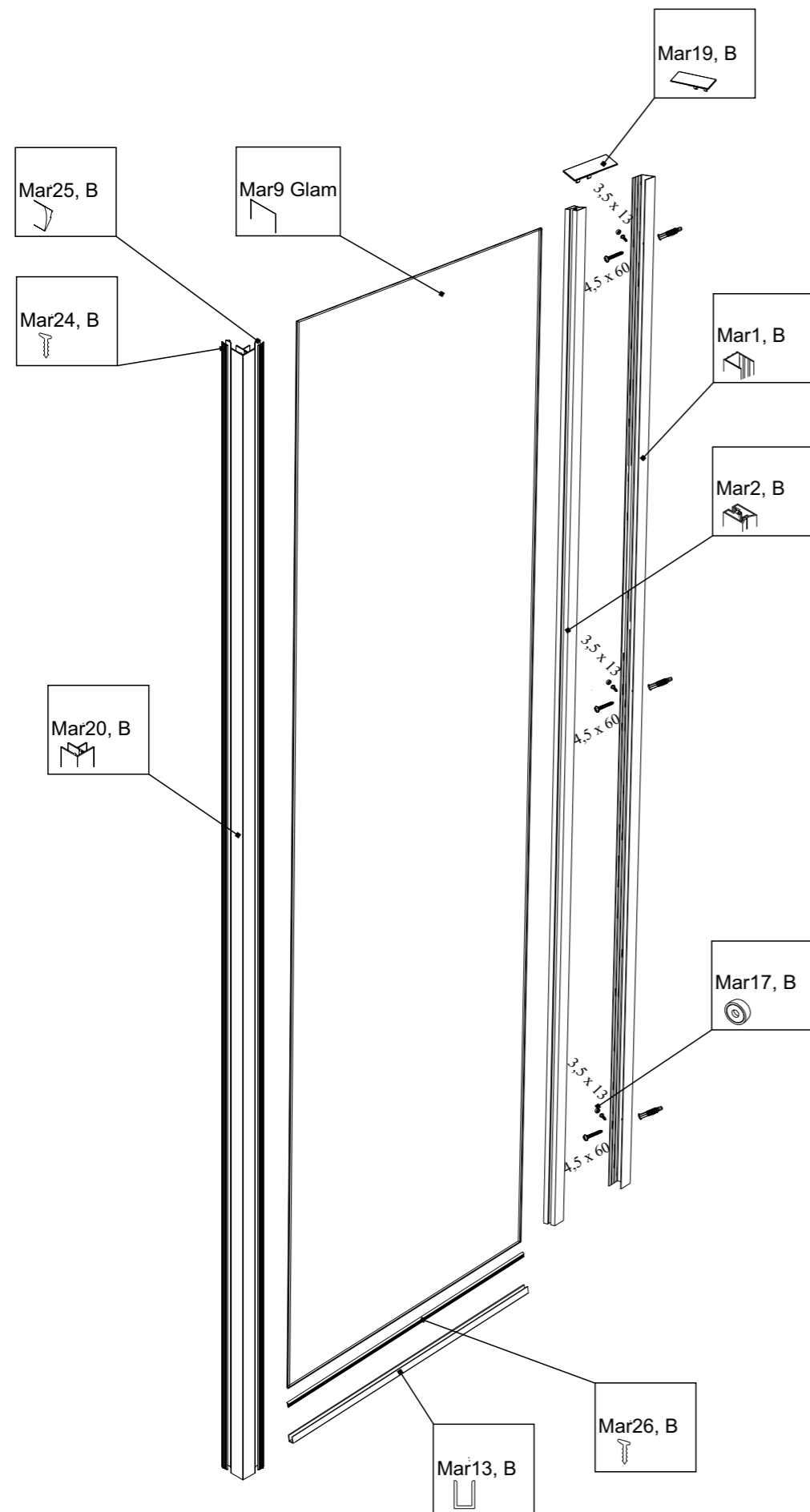
<p>Mar1, S Mar1, B</p>  <p>x1</p>	<p>Mar2, S Mar2, B</p>  <p>x1</p>	<p>Mar3, S Mar3, B</p>  <p>x1</p>	<p>Mar4</p>  <p>x1</p>
<p>Mar5, S Mar5, B</p>  <p>x2</p>	<p>Mar6, S Mar6, B</p>  <p>x2</p>	<p>Mar7</p>  <p>x2</p>	<p>Mar8 Pro Mar8 Relj Mar8 Sivo</p>  <p>x1</p>
<p>Mar9 Pro Mar9 Relj Mar9 Sivo</p>  <p>x1</p>	<p>Mar10 L, S Mar10 L, B</p>  <p>x1</p>	<p>Mar11 D, S Mar11 D, B</p>  <p>x1</p>	<p>Mar12, S Mar12, B</p>  <p>x1</p>
<p>Mar13, S Mar13, B</p>  <p>x1</p>	<p>Mar14, S Mar14, B</p>  <p>x1</p>	<p>Mar15, S Mar15, B</p>  <p>x1</p>	<p>Mar16, S Mar16, B</p>  <p>x1</p>
<p>Mar17, S Mar17, B</p>  <p>x3</p>	<p>Mar19, S Mar19, B</p>  <p>x1</p>	<p>Mar26, S Mar26, B</p>  <p>x1</p>	<p>Mar27, S Mar27, B</p>  <p>x1</p>
<p>Mar18</p> <p>3x 3x 3x 2x</p>  <p>3,5 x 13</p>  <p>4,5 x 60</p>  <p>Ø 8mm</p>  <p>3,5 x 38</p>			



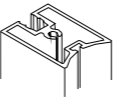
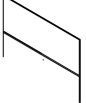
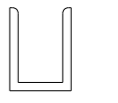

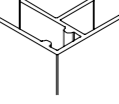



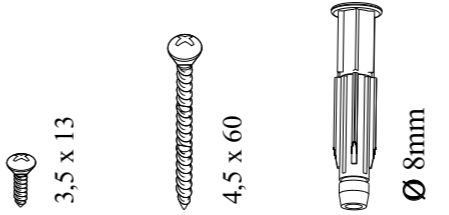

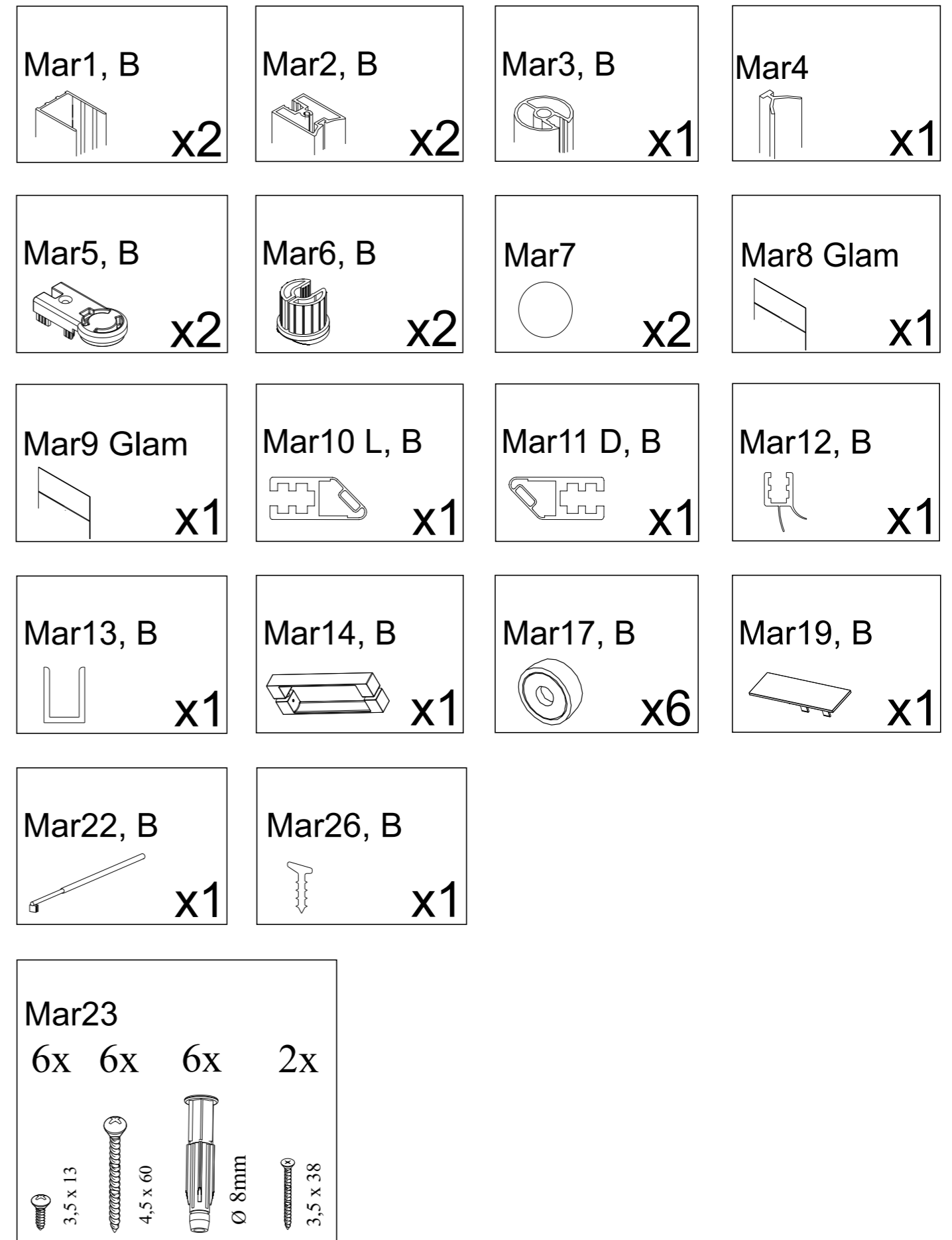
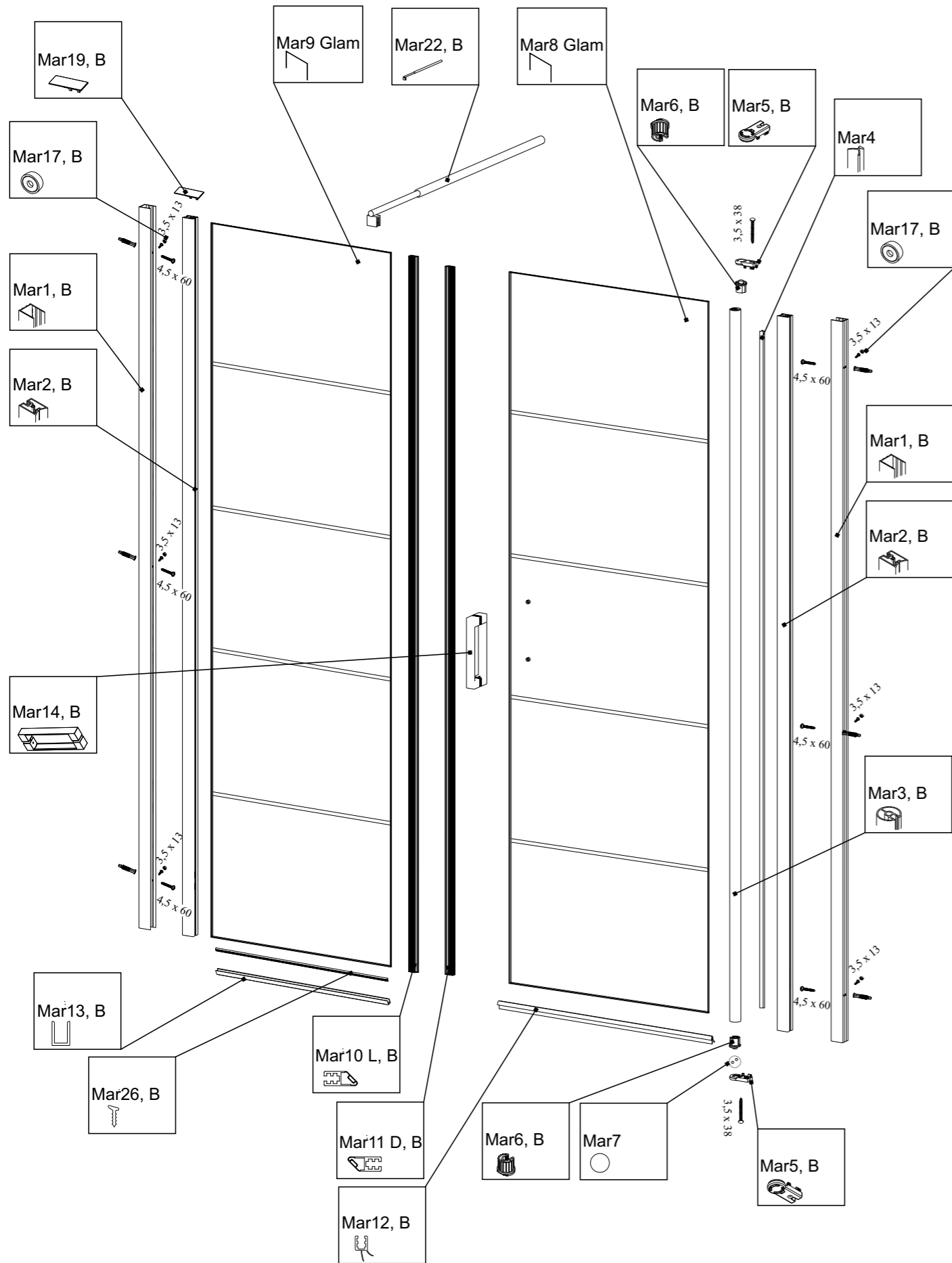



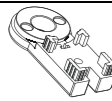
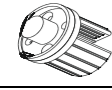

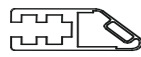

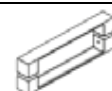

<p>Mar1, B</p>  <p>x1</p>	<p>Mar2, B</p>  <p>x1</p>	<p>Mar3, B</p>  <p>x1</p>	<p>Mar4</p>  <p>x1</p>
<p>Mar5, B</p>  <p>x2</p>	<p>Mar6, B</p>  <p>x2</p>	<p>Mar7</p>  <p>x2</p>	<p>Mar8 Glam</p>  <p>x1</p>
<p>Mar9 Glam</p>  <p>x1</p>	<p>Mar10 L, B</p>  <p>x1</p>	<p>Mar11 D, B</p>  <p>x1</p>	<p>Mar12, B</p>  <p>x1</p>
<p>Mar13, B</p>  <p>x1</p>	<p>Mar14, B</p>  <p>x1</p>	<p>Mar15, B</p>  <p>x1</p>	<p>Mar16, B</p>  <p>x1</p>
<p>Mar17, B</p>  <p>x3</p>	<p>Mar26, B</p>  <p>x1</p>		
<p>Mar18</p> <p>3x 3x 3x 2x</p>  <p>3,5 x 13 4,5 x 60 Ø 8mm 3,5 x 38</p>			



<p>Mar1, B</p>  <p>x1</p>	<p>Mar2, B</p>  <p>x1</p>	<p>Mar9 Glam</p>  <p>x1</p>	<p>Mar13, B</p>  <p>x1</p>
<p>Mar17, B</p>  <p>x3</p>	<p>Mar19, B</p>  <p>x1</p>	<p>Mar20, B</p>  <p>x1</p>	<p>Mar24, B</p>  <p>x2</p>
<p>Mar25, B</p>  <p>x2</p>	<p>Mar26, B</p>  <p>x1</p>		
<p>Mar21</p> <p>3x 3x 3x</p>  <p>3,5 x 13 4,5 x 60 Ø 8mm</p>			



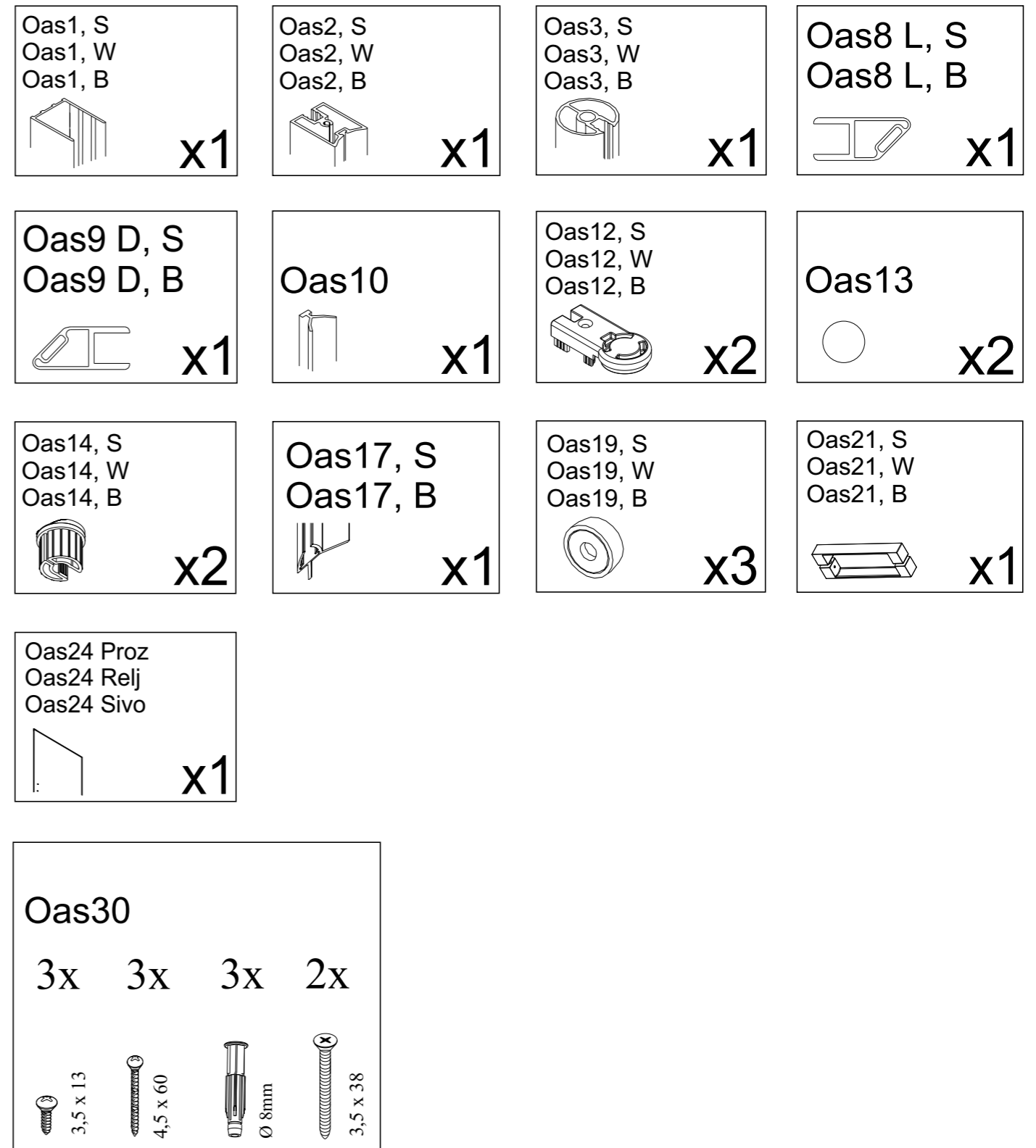
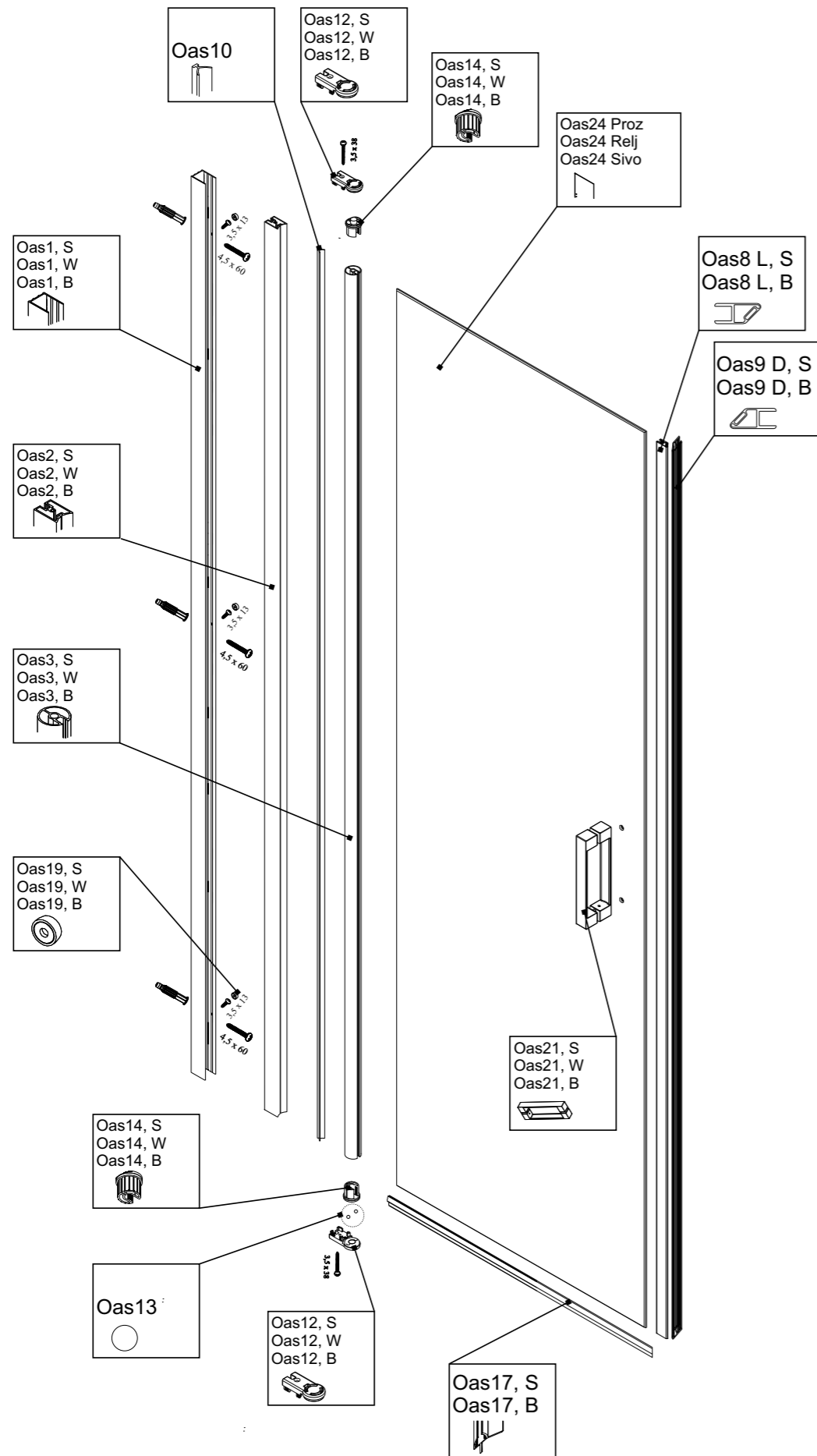

MARS / MARS II	Specif. br.	Šifra	Opis
	Mar4	3112013	PVC profil ART.375, L=1990 mm, za Oasis D
	Mar5, S	3113355	Eco lift sistem, fiksna plastika, siva
	Mar5, B	3113351	Eco lift sistem, fiksna plastika, crna
	Mar6, S	3113356	Eco lift sistem, okretna plastika, siva
	Mar6, B	3113352	Eco lift sistem, okretna plastika, crna
	Mar7	3113186	Metalna kuglica fi 6 mm
	Mar10 L,S	3112083	PVC profil mag. M 126 L, V6 L=2000 mm, transp. sivi mag
	Mar10 L,B	3112094	PVC profil mag M 126 L,V6 L=2000 mm, crni
	Mar11 D, S	3112084	PVC profil mag M 126 D,V6 L=2000 mm, transp.sivi mag
	Mar11 D, B	3112093	PVC profil mag M 126 D,V6 L=2000 mm, crni
	Mar12, S	3112016	PVC profil E-504 V6, L=2000 mm azurna, za st. 6 mm - TITAN
	Mar12, B	3112095	PVC profil G 026 V6, L=2000 mm, crni, pera 12 mm
	Mar13, S	6100121	Alu. profil U 15x11x15, L=1100 mm, silver
	Mar13, B	6100122	Alu. profil U 15x11x15, L=1100 mm, crna mat
	Mar13, S	6100116	Alu. profil U 15x11x15, L=1400 mm, silver, Mars W (120-140)
	Mar13, B	6100118	Alu. profil U 15x11x15, L=1400 mm, crna mat, Mars W (120-140)
	Mar14, S	3113054	Ručke za tuš kabinu cod. 1015 - chrom
	Mar14, B	3113096	Ručke za tuš kabinu cod. 1015 - crna mat
	Mar15, S	3113034	Šipka za fiksiranje L=1990 mm kvadratna, brill
	Mar15, S	3113031	Šipka za fiksiranje L=1490 mm kvadratna, brill
	Mar15, S	3113033	Šipka za fiksiranje L=990 mm kvadratna, brill
	Mar16, S	3113032	Šipka za fiksiranje L=100 mm kvadratna, brill
	Mar15, B	3113296	Šipka za fiksiranje L=1990 mm, kvadratna, crna mat
	Mar15, B	3113085	Šipka za fiksiranje L=1490 mm, kvadratna, crna mat
	Mar15, B	3113084	Šipka za fiksiranje L=990 mm, kvadratna, crna mat
	Mar16, B	3113086	Šipka za fiksiranje L=100 mm, kvadratna, crna mat
	Mar17, S	3113130	Ukrasna kapica s podloškom, siva
	Mar17, B	3113131	Ukrasna kapica s podloškom, crna
	Mar19, S	3113207	Poklopac za zid. prof. Oasis, Mars, Aurora - sivi
	Mar19, B	3113208	Poklopac za zidni profil Oasis, Mars - crni
	Mar20, S	6100090	Alu. profil R11391, brillant, 1992 mm
	Mar20, B	6100091	Alu. profil R11391, crna mat, 1992 mm

MARS / MARS II	Specif. br.	Šifra	Opis
	Mar22, S	3111083	Šipka za fiksiranje stijene, chrom
	Mar22, B	3111086	Šipka za fiksiranje stijene, crna mat
	Mar24, S	3112024	PVC profil F60/2 vertikalni za profil E-8854, prozi, L=2000 mm
	Mar24, B	3112024C	PVC profil F60/2 vertikalni za profil E-8854, crni, L=2000 mm
	Mar25, S	3112092	PVC profil obostrani 1 mm, L=2000 mm
	Mar25, B	3113313	PVC profil obostrani 1 mm, L=2000 mm, crna
	Mar26, S	3112024	PVC profil F60/2 vertikalni za profil E-8854, prozi, L=1100 mm PVC profil F60/2 vertikalni za profil E-8854, prozi, L=1400 mm, Mars W (120-140)
	Mar26, B	3112024C	PVC profil F60/2 vertikalni za profil E-8854, crna, L=1100 mm PVC profil F60/2 vertikalni za profil E-8854, crna, L=1400 mm, Mars W (120-140)

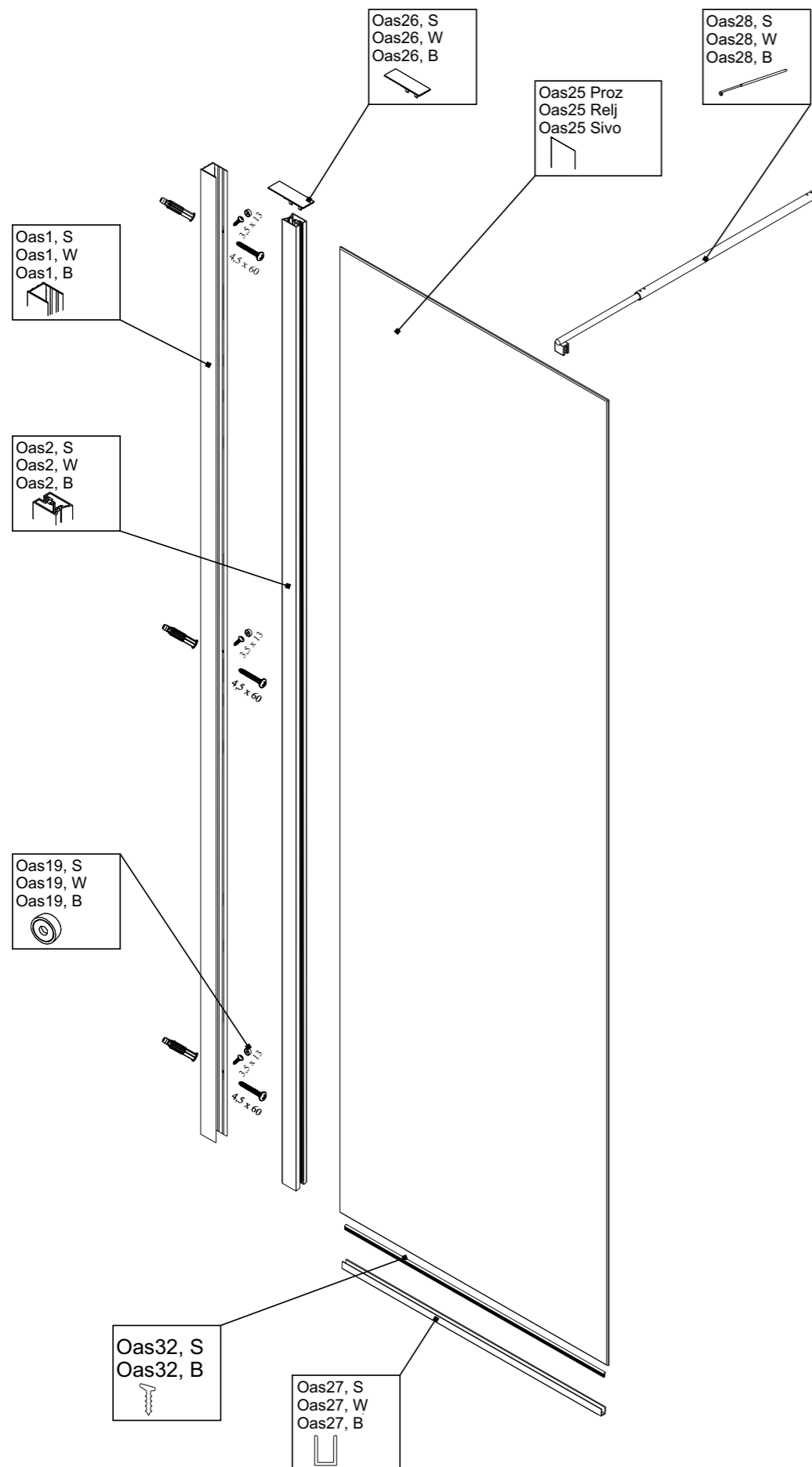

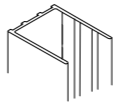
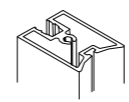
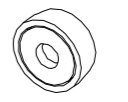
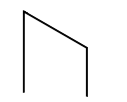
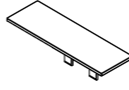
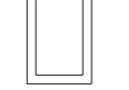

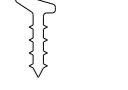
- | | | | |
|--|--|--|--|
| <p>Oas1, S
Oas1, W
Oas1, B</p>  <p>x1</p> | <p>Oas2, S
Oas2, W
Oas2, B</p>  <p>x1</p> | <p>Oas19, S
Oas19, W
Oas19, B</p>  <p>x3</p> | <p>Oas25 Proz
Oas25 Relj
Oas25 Sivo</p>  <p>x1</p> |
| <p>Oas26, S
Oas26, W
Oas26, B</p>  <p>x1</p> | <p>Oas27, S
Oas27, W
Oas27, B</p>  <p>x1</p> | <p>Oas28, S
Oas28, W
Oas28, B</p>  <p>x1</p> | <p>Oas32, S
Oas32, B</p>  <p>x1</p> |
- Oas31**

3x 3x 3x

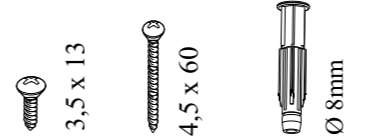



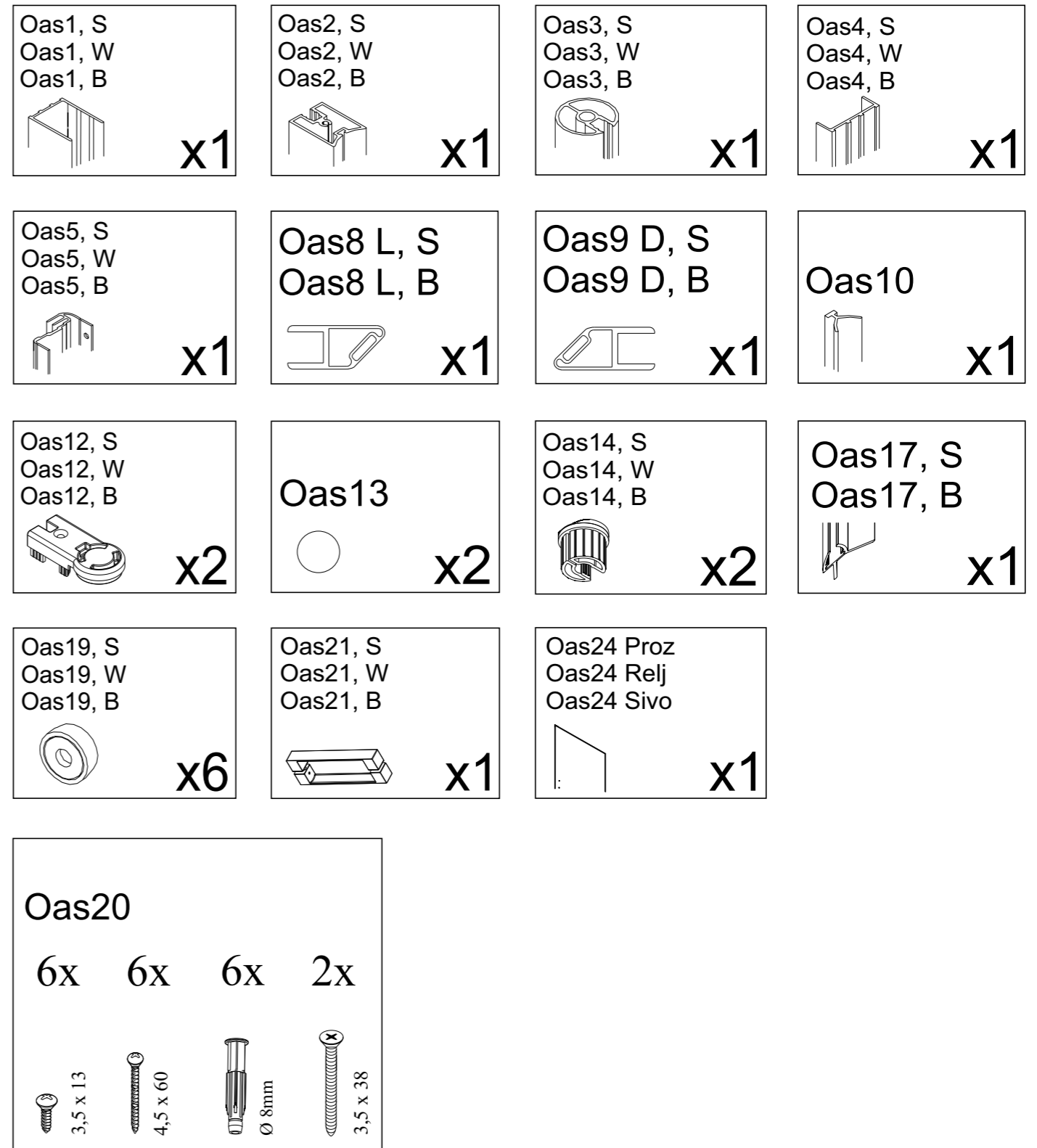
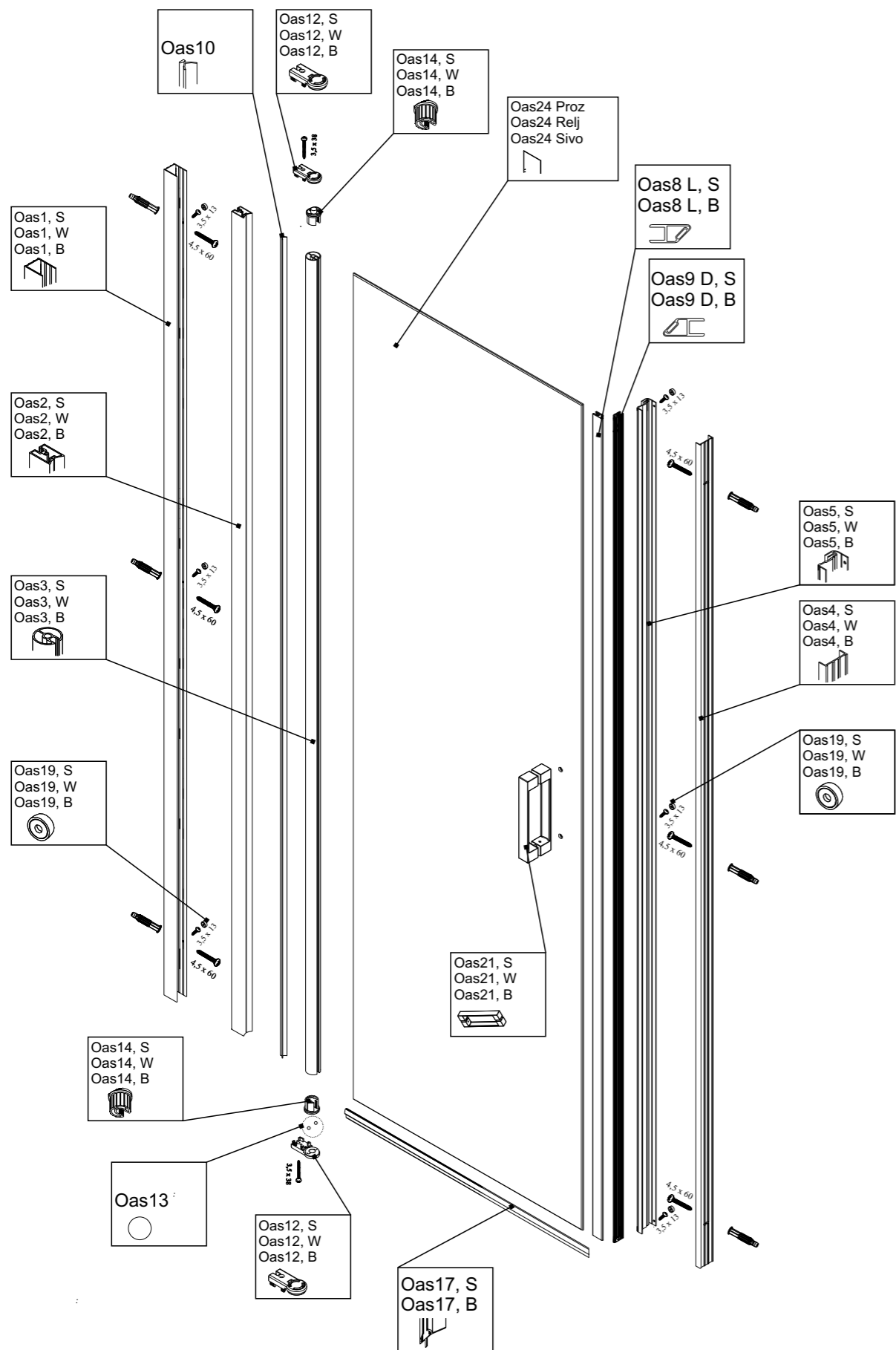

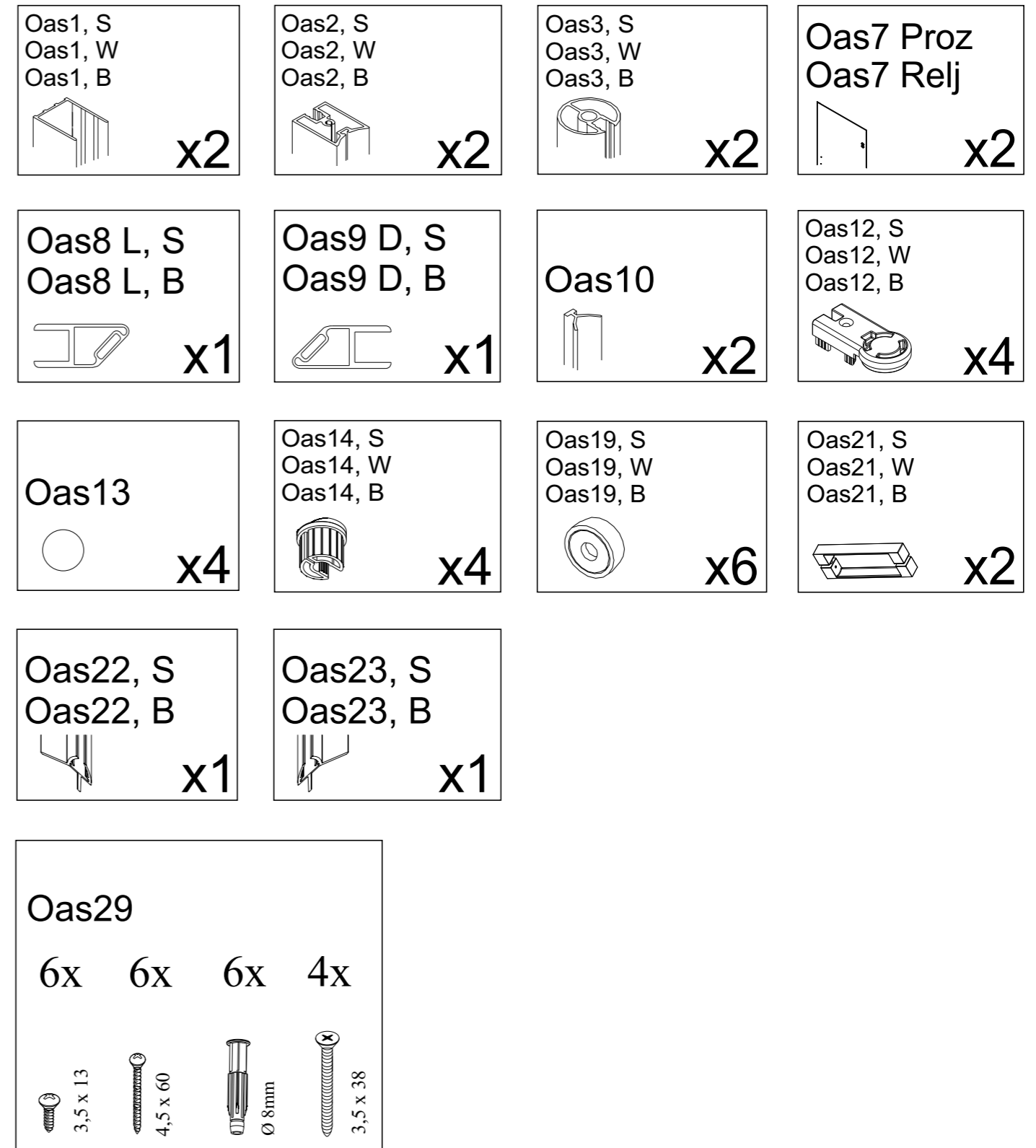
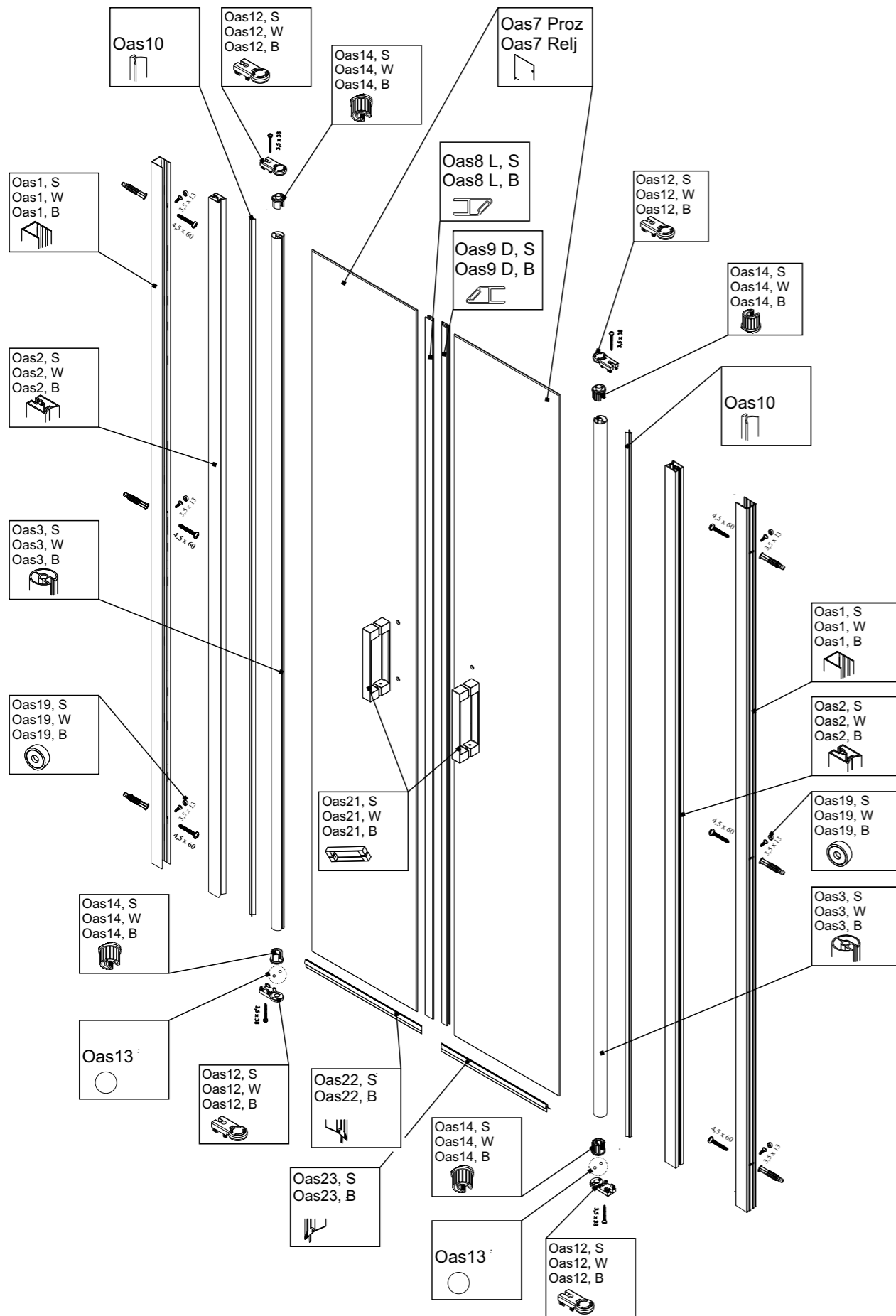

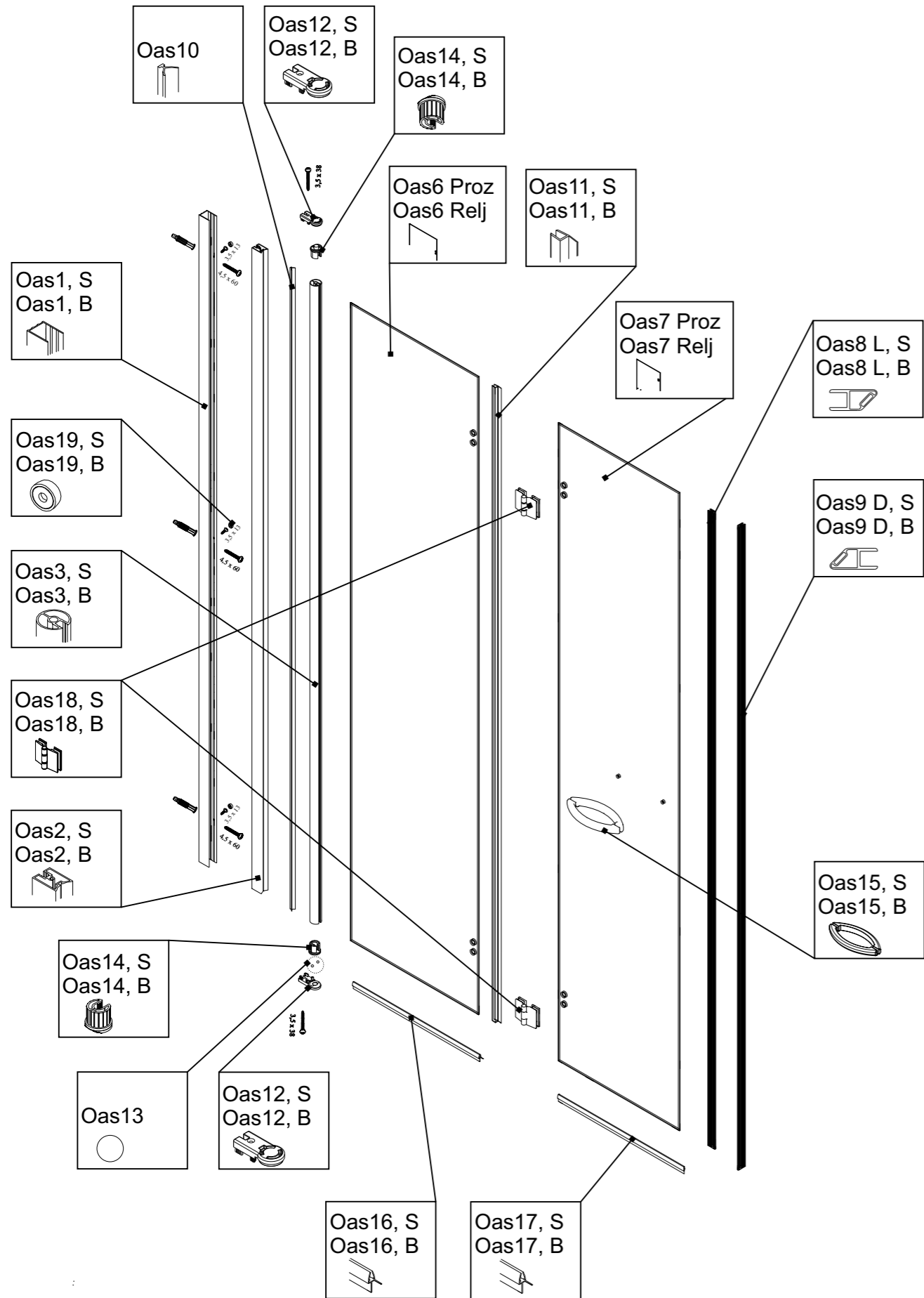

3,5 x 13 4,5 x 60 Ø 8mm

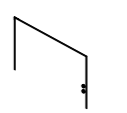
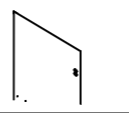
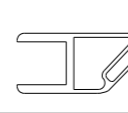
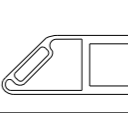

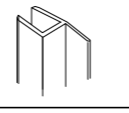
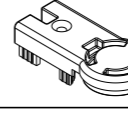
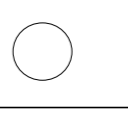

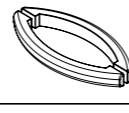
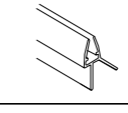
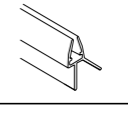
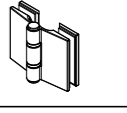

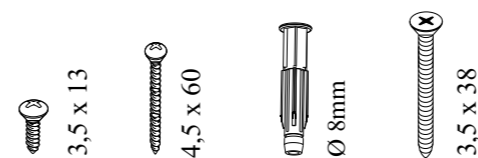

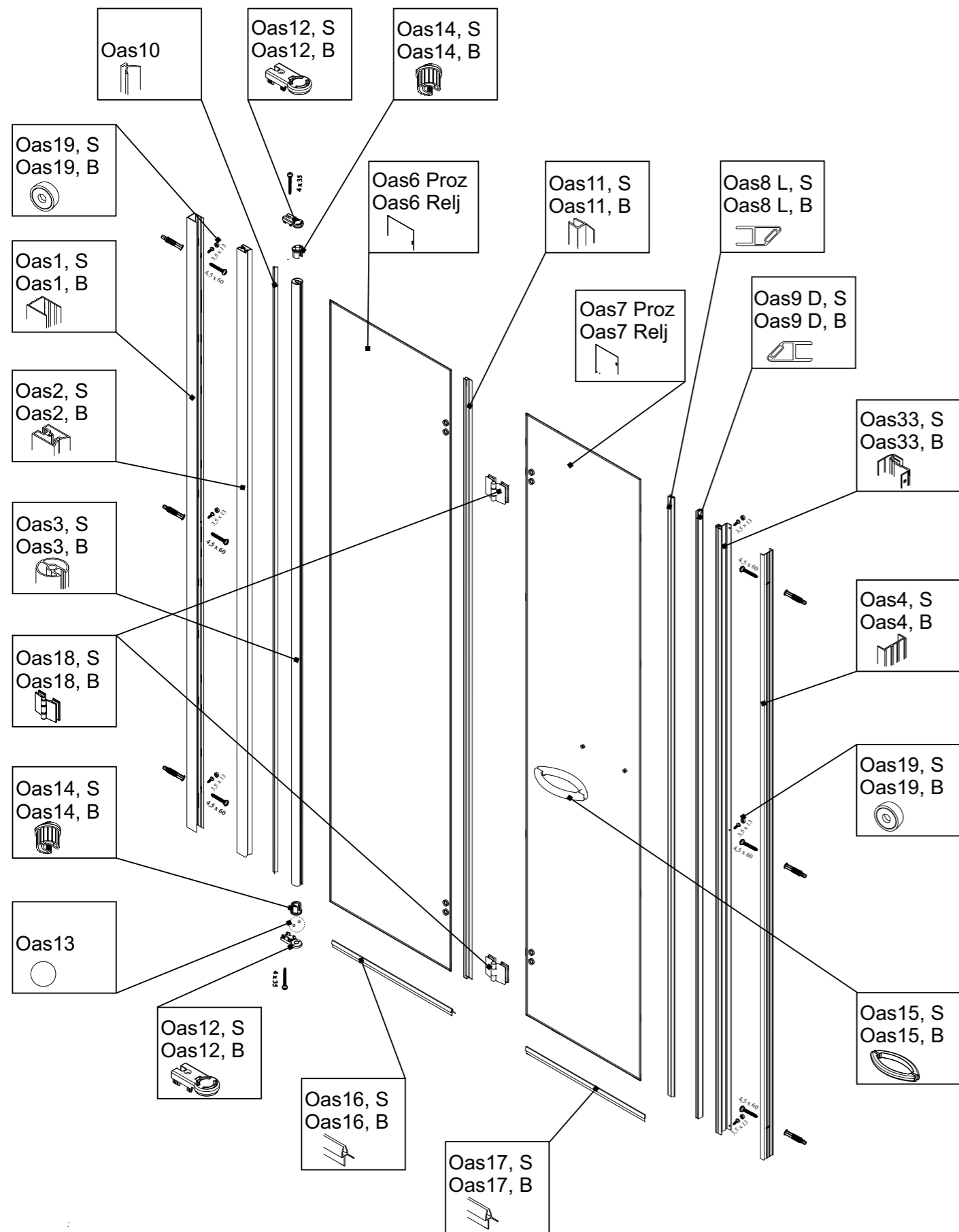

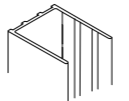
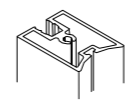

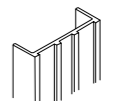
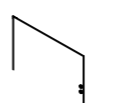
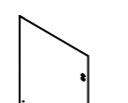
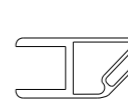
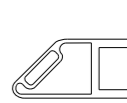

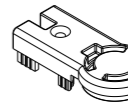
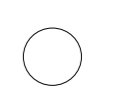

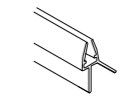
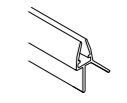
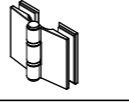





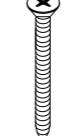

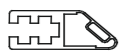
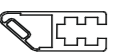

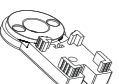

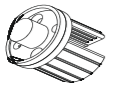

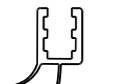

- | | | | |
|--|--|--|--|
| Oas1, S
Oas1, B
 x1 | Oas2, S
Oas2, B
 x1 | Oas3, S
Oas3, B
 x1 | Oas6 Proz
Oas6 Relj
 x1 |
| Oas7 Proz
Oas7 Relj
 x1 | Oas8 L, S
Oas8 L, B
 x1 | Oas9 D, S
Oas9 D, B
 x1 | Oas10
 x1 |
| Oas11, S
Oas11, B
 x1 | Oas12, S
Oas12, B
 x2 | Oas13
 x2 | Oas14, S
Oas14, B
 x2 |
| Oas15, S
Oas14, B
 x1 | Oas16, S
Oas16, B
 x1 | Oas17, S
Oas17, B
 x1 | Oas18, S
Oas18, B
 x2 |
| Oas19, S
Oas19, B
 x3 | | | |
| <p>Oas30</p> <p>3x 3x 3x 2x</p>  | | | |









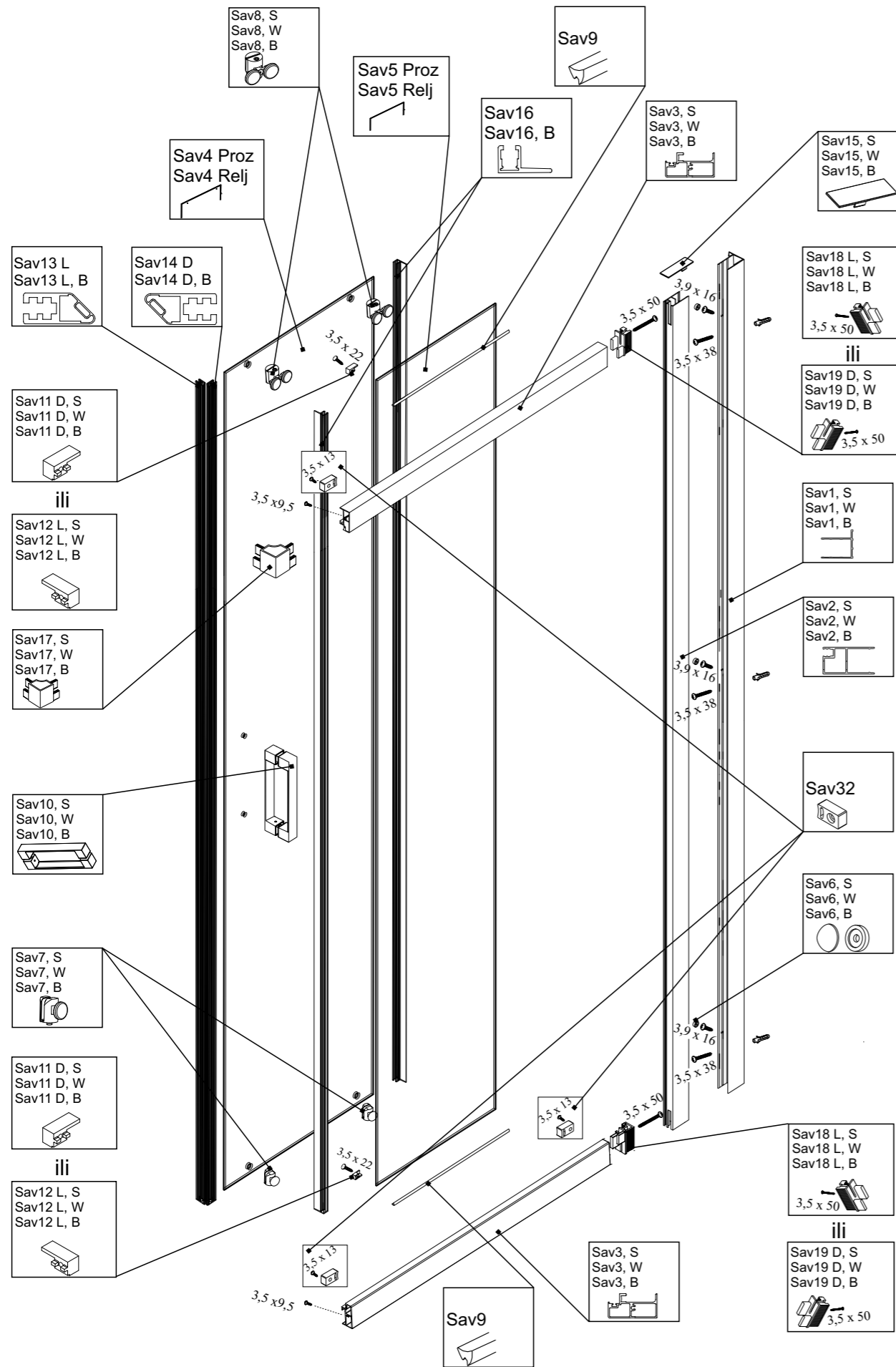

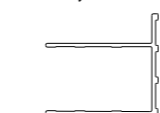
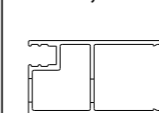
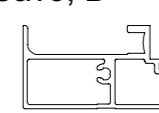
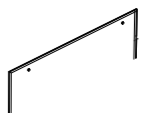
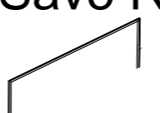

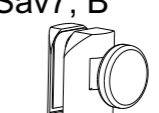
- | | | | |
|---|--|--|--|
| Oas1, S
Oas1, B
 x1 | Oas2, S
Oas2, B
 x1 | Oas3, S
Oas3, B
 x1 | Oas4, S
Oas4, B
 x1 |
| Oas6 Proz
Oas6 Relj
 x1 | Oas7 Proz
Oas7 Relj
 x1 | Oas8 L, S
Oas8 L, B
 x1 | Oas9 D, S
Oas9 D, B
 x1 |
| Oas10
 x1 | Oas11, S
Oas11, B
 x1 | Oas12, S
Oas12, B
 x2 | Oas13
 x2 |
| Oas14, S
Oas14, B
 x2 | Oas15, S
Oas15, B
 x1 | Oas16, S
Oas16, B
 x1 | Oas17, S
Oas17, B
 x1 |
| Oas18, S
Oas18, B
 x2 | Oas19, S
Oas19, B
 x6 | Oas33, S
Oas33, B
 x1 | |
| Oas20
6x 6x 6x 2x
 3,5 x 13  4,5 x 60  Ø 8mm  3,5 x 38 | | | |

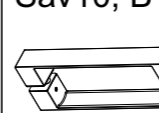
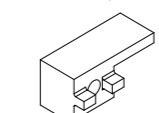
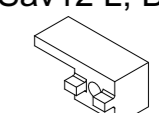
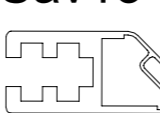
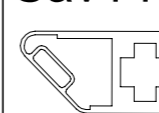

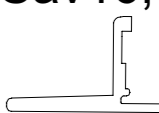
OASIS	Specif. br.	Šifra	Opis
	Oas8 L, S	3112083	PVC profil mag M 126 L, V6 L=2000 mm, transp.sivi mag
	Oas8 L, B	3112094	PVC profil mag M 126 L, V6 L=2000 mm, crna
	Oas9 D, S	3112084	PVC profil mag M 126 D, V6 L=2000 mm, transp.sivi mag
	Oas9 D, B	3112093	PVC profil mag M 126 D, V6 L=2000 mm, crna
	Oas10	3112013	PVC profil ART.375, L=1990 mm, za Oasis D
	Oas11, S	3112070	PVC profil G 046 V6, L=1970 mm transp, za staklo 6 mm
	Oas11, B	3112000	PVC profil G 046 V6, L=2200 mm crna, za staklo 6 mm
	Oas12, S	3113355	Eco lift sistem, fiksna plastika, siva
	Oas12, W	3113353	Eco lift sistem, fiksna plastika, bijela
	Oas12, B	3113351	Eco lift sistem, fiksna plastika, crna
	Oas13	3113186	Metalna kuglica fi 6 mm
	Oas14, S	3113356	Eco lift sistem, okretna plastika, siva
	Oas14, W	3113354	Eco lift sistem, okretna plastika, bijela
	Oas14, B	3113352	Eco lift sistem, okretna plastika, crna
	Oas15, S	3113059	Ručka za tuš paravan Oasis d+p, chrom
	Oas15, B	3113064	Ručka za tuš paravan Oasis d+p, crna mat
	Oas16, S Oas17, S Oas22, S Oas23, S	3112016	PVC profil E-504 V6, L=2000mm azurna, za staklo 6 mm - TITAN
	Oas16, B Oas17, B Oas22, B Oas23, B	3112095	PVC profil G 026 V6, L=2000mm, crna, pera 12 mm
	Oas18, S	3113030	Metalni pant SACERO1 CR (Oasis)
	Oas18, B	3113048	Metalni pant SACERO1 CR (Oasis), crna mat
	Oas19, S	3113130	Ukrasna kapica s podloškom, siva
	Oas19, W	3113129	Ukrasna kapica s podloškom, bijela
	Oas19, B	3113131	Ukrasna kapica s podloškom, crna
	Oas21, S	3113054	Ručke za tuš kabinu cod. 1015 - chrom
	Oas21, W	3113055	Ručke za tuš kabinu cod. 1015 - bijela
	Oas21, B	3113096	Ručke za tuš kabinu cod. 1015 - crna mat
	Oas26, S	3113207	Poklopac za zid. prof. Oasis, Mars, Aurora - sivi
	Oas26, W	3113206	Poklopac za zidni profil Oasis - bijeli
	Oas26, B	3113208	Poklopac za zidni profil Oasis, Mars - crni

OASIS	Specif. br.	Šifra	Opis
	Oas27, S	6100035	Alu. profil U 15x11x15, L=1000 mm, silver, Oasis W (70-100)
		6100116	Alu. profil U 15x11x15, L=1400 mm, silver, Oasis W (110-140)
	Oas27, W	6100086	Alu. profil U 15x11x15, L=1000 mm, bijela, Oasis W (70-100)
		6100117	Alu. profil U 15x11x15, L=1400 mm, bijela, Oasis W (110-140)
	Oas27, B	6100062	Alu. profil U 15x11x15, L=1000 mm, crna mat, Oasis W (70-100)
		6100118	Alu. profil U 15x11x15, L=1400 mm, crna mat, Oasis W (110-140)
	Oas28, S	3111083	Šipka za fiksiranje stijene, chrom
	Oas28, W	3111084	Šipka za fiksiranje stijene, bijela
	Oas28, B	3111086	Šipka za fiksiranje stijene, crna mat
	Oas32, S	3112024	PVC profil F60/2 vertikalni za profil E-8854, prozi, L=1000 mm PVC profil F60/2 vertikalni za profil E-8854, prozi, L=1400 mm, Oasis W (110-140)
	Oas32, B	3112024C	PVC profil F60/2 vertikalni za profil E-8854, crni, L=1000 mm PVC profil F60/2 vertikalni za profil E-8854, crni, L=1400 mm, Oasis W (110-140)

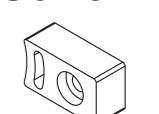
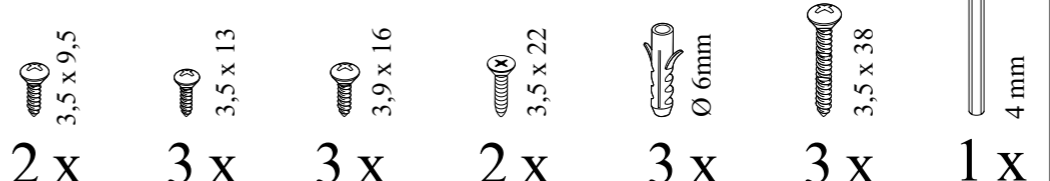

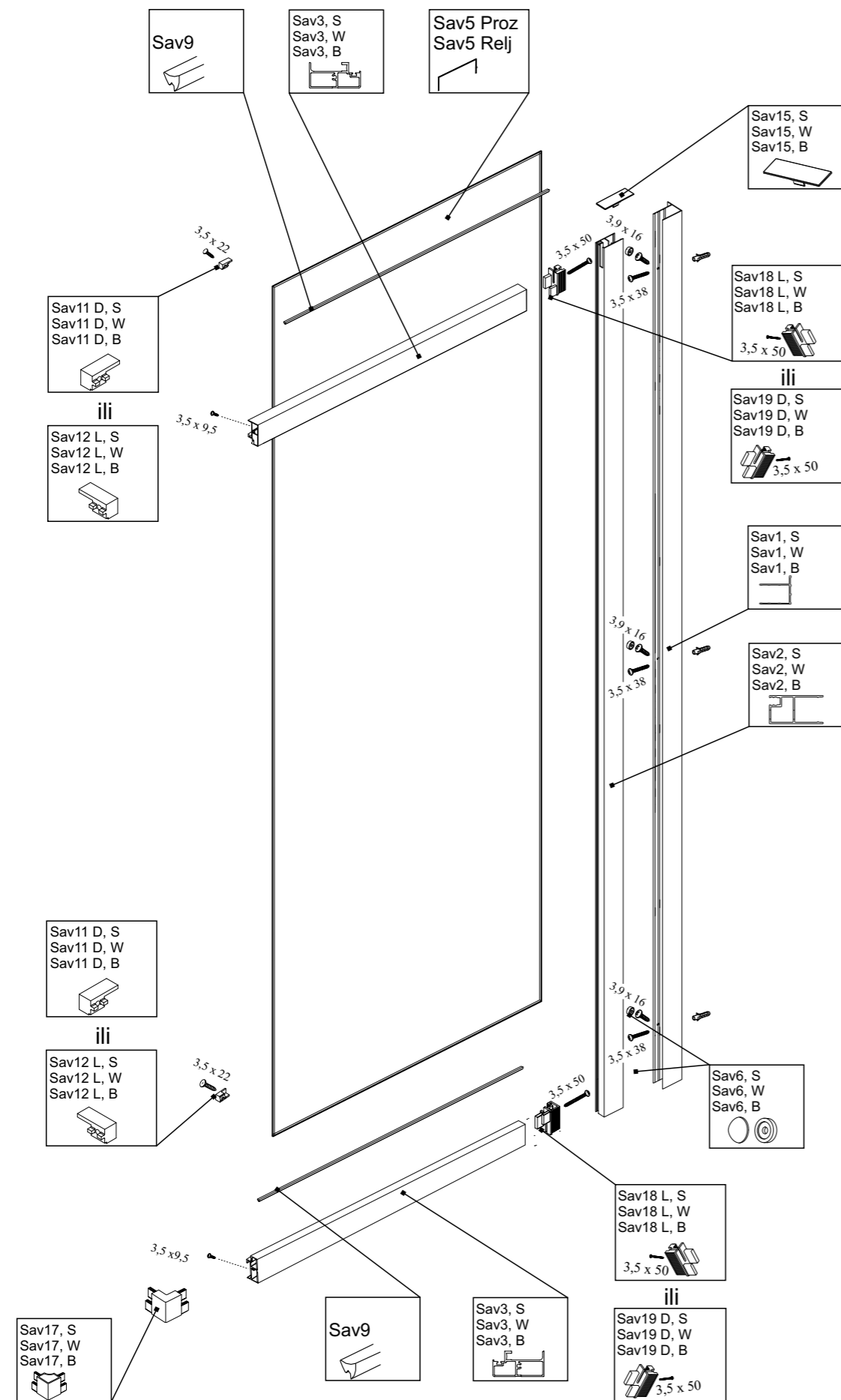

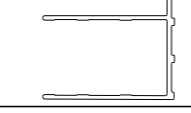
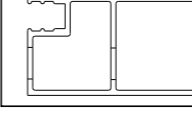
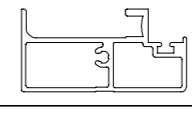
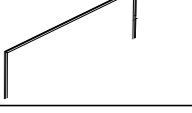

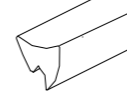
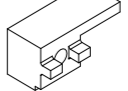
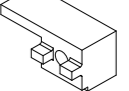
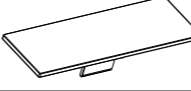
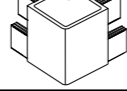
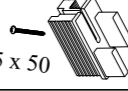
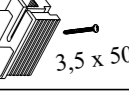
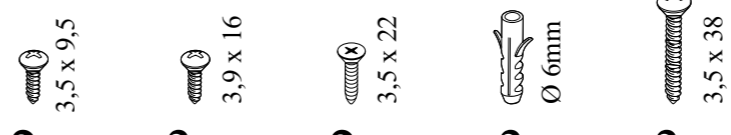

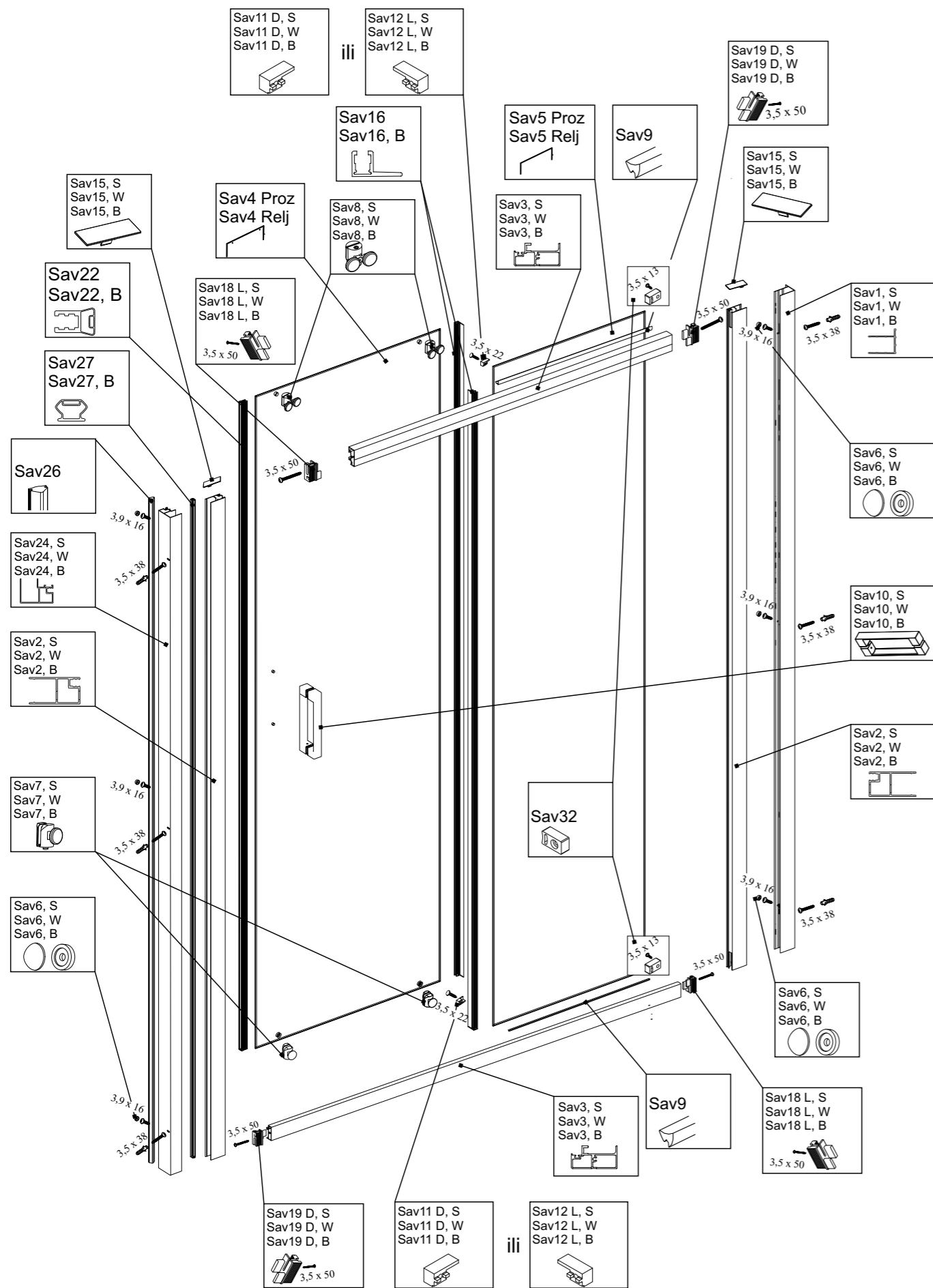
Sav1, S Sav1, W Sav1, B  x1	Sav2, S Sav2, W Sav2, B  x1	Sav3, S Sav3, W Sav3, B  x2	Sav4 Proz Sav4 Relj  x1
Sav5 Proz Sav5 Relj  x1	Sav6, S Sav6, W Sav6, B  x2	Sav7, S Sav7, W Sav7, B  x2	Sav8, S Sav8, W Sav8, B  x2
Sav9  x2	Sav10, S Sav10, W Sav10, B  x1	Sav11 D, S Sav11 D, W Sav11 D, B  x1	Sav12 L, S Sav12 L, W Sav12 L, B  x1
Sav13 L Sav13 L, B  x1	Sav14 D, Sav14 D, B  x1	Sav15, S Sav15, W Sav15, B  x1	Sav16 Sav16, B  x2
Sav17, S Sav17, W Sav17, B  x1	Sav18 L, S Sav18 L, W Sav18 L, B  x1	Sav19 D, S Sav19 D, W Sav19 D, B  x1	Sav32  x3
Sav20  2 x 3,5 x 9,5 3 x 3,5 x 13 3 x 3,9 x 16 2 x 3,5 x 22 3 x Ø 6mm 3 x 3,5 x 38 1 x 4 mm			

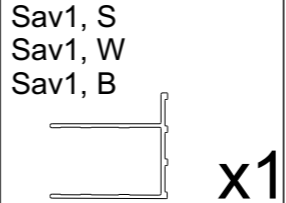
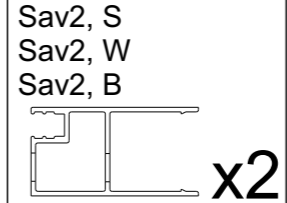
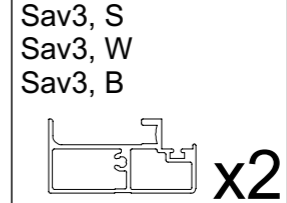

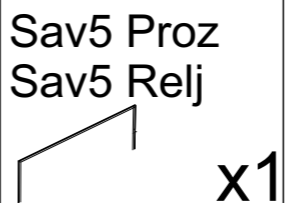
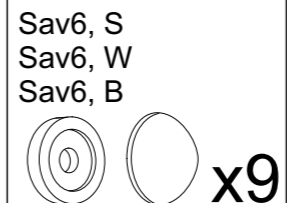
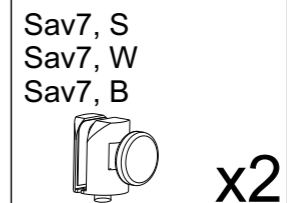
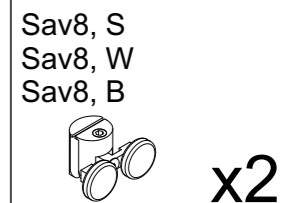

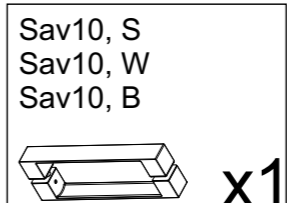
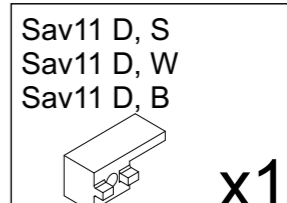
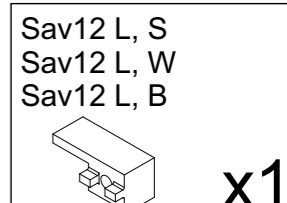
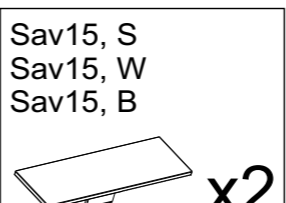
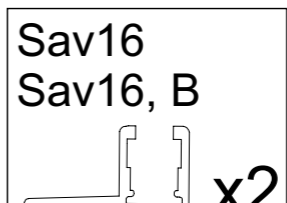
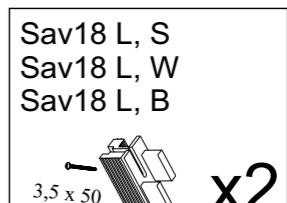
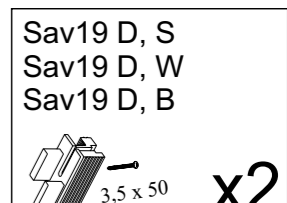
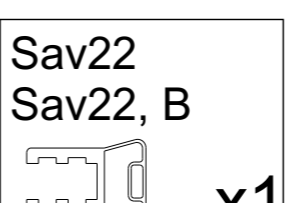
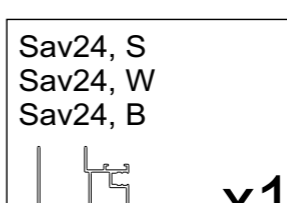

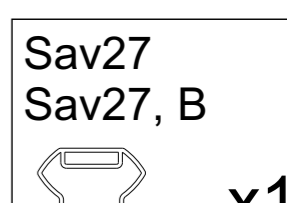
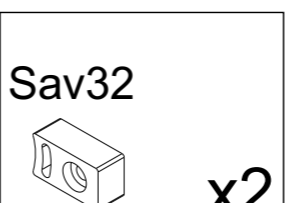
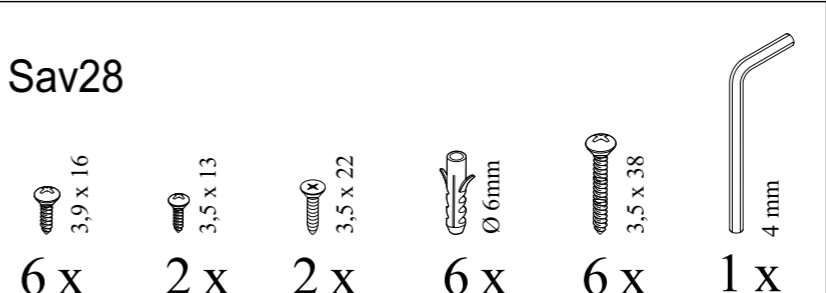

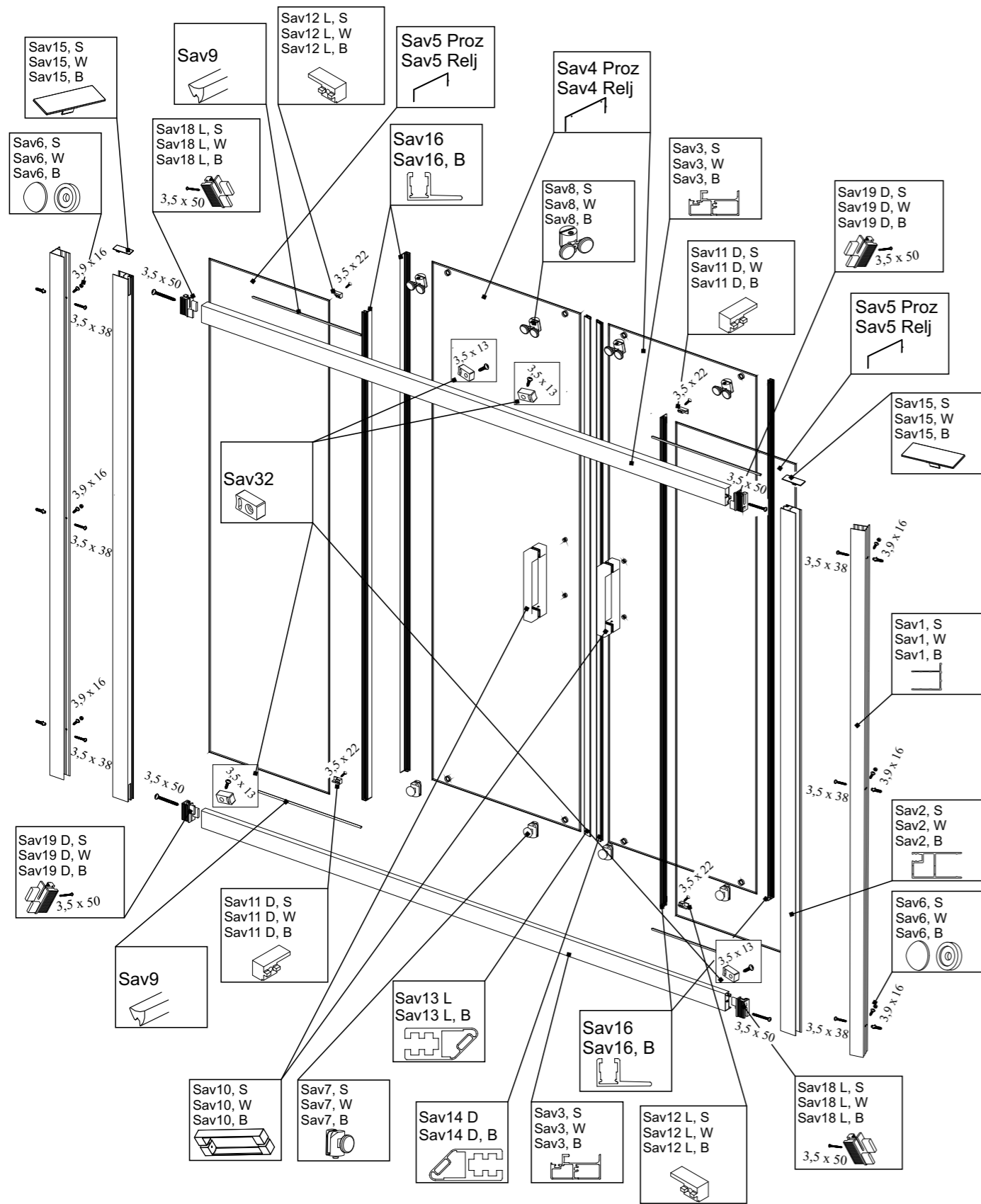

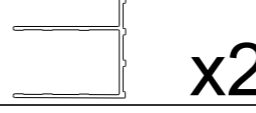
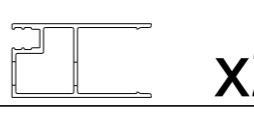
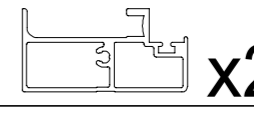
<p>Sav1, S Sav1, W Sav1, B</p>  <p>x1</p>	<p>Sav2, S Sav2, W Sav2, B</p>  <p>x1</p>	<p>Sav3, S Sav3, W Sav3, B</p>  <p>x2</p>	<p>Sav5 Proz Sav5 Relj</p>  <p>x1</p>
<p>Sav6, S Sav6, W Sav6, B</p>  <p>x6</p>	<p>Sav9</p>  <p>x2</p>	<p>Sav11 D, S Sav11 D, W Sav11 D, B</p>  <p>x1</p>	<p>Sav12 L, S Sav12 L, W Sav12 L, B</p>  <p>x1</p>
<p>Sav15, S Sav15, W Sav15, B</p>  <p>x1</p>	<p>Sav17, S Sav17, W Sav17, B</p>  <p>x1</p>	<p>Sav18 L, S Sav18 L, W Sav18 L, B</p>  <p>x1</p>	<p>Sav19 D, S Sav19 D, W Sav19 D, B</p>  <p>x1</p>
<p>Sav21</p>  <p> 3,5 x 9,5 3,9 x 16 3,5 x 22 Ø 6mm 3,5 x 38 2 x 3 x 2 x 3 x 3 x </p>			



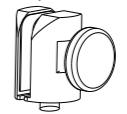
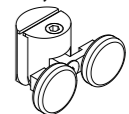

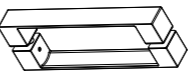
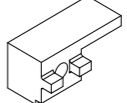
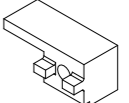
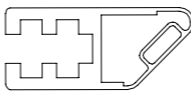
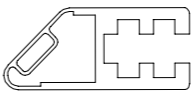
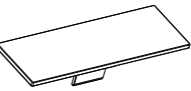

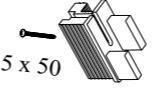
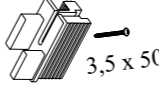
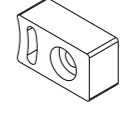
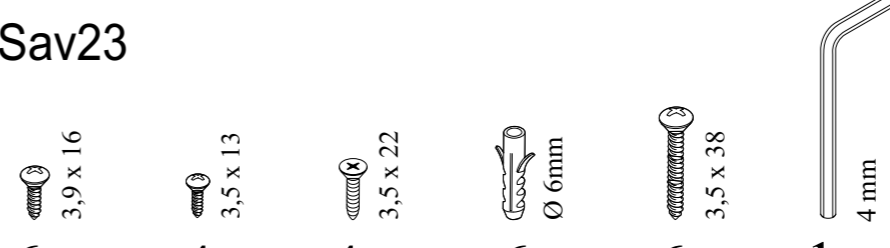
- | | | | |
|---|--|---|---|
| Sav1, S
Sav1, W
Sav1, B
 x1 | Sav2, S
Sav2, W
Sav2, B
 x2 | Sav3, S
Sav3, W
Sav3, B
 x2 | Sav4 Proz
Sav4 Relj
 x1 |
| Sav5 Proz
Sav5 Relj
 x1 | Sav6, S
Sav6, W
Sav6, B
 x9 | Sav7, S
Sav7, W
Sav7, B
 x2 | Sav8, S
Sav8, W
Sav8, B
 x2 |
| Sav9
 x2 | Sav10, S
Sav10, W
Sav10, B
 x1 | Sav11 D, S
Sav11 D, W
Sav11 D, B
 x1 | Sav12 L, S
Sav12 L, W
Sav12 L, B
 x1 |
| Sav15, S
Sav15, W
Sav15, B
 x2 | Sav16
Sav16, B
 x2 | Sav18 L, S
Sav18 L, W
Sav18 L, B
 x2 | Sav19 D, S
Sav19 D, W
Sav19 D, B
 x2 |
| Sav22
Sav22, B
 x1 | Sav24, S
Sav24, W
Sav24, B
 x1 | Sav26
 x1 | Sav27
Sav27, B
 x1 |
| Sav32
 x2 | | | |
| <p>Sav28</p>  <p>6 x 3,9 x 16 2 x 3,5 x 13 2 x 3,5 x 22 6 x Ø 6mm 6 x 3,5 x 38 1 x 4 mm</p> | | | |

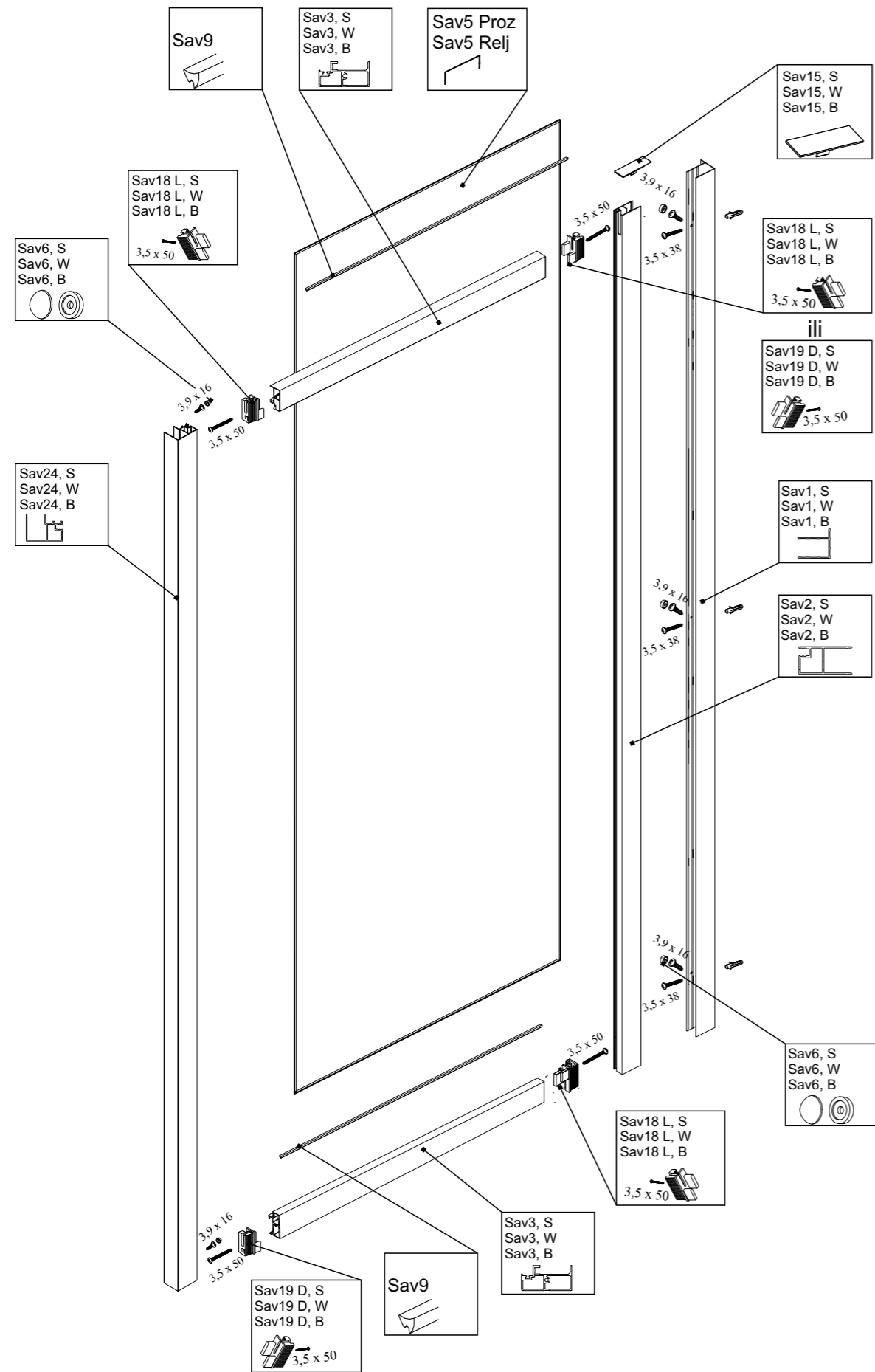

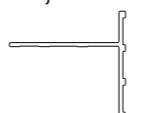
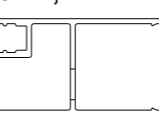
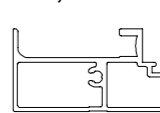

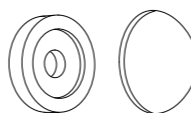
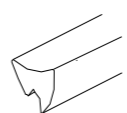
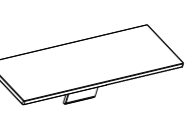
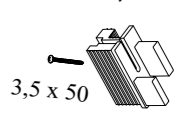
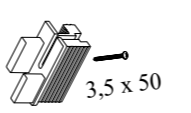
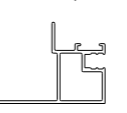



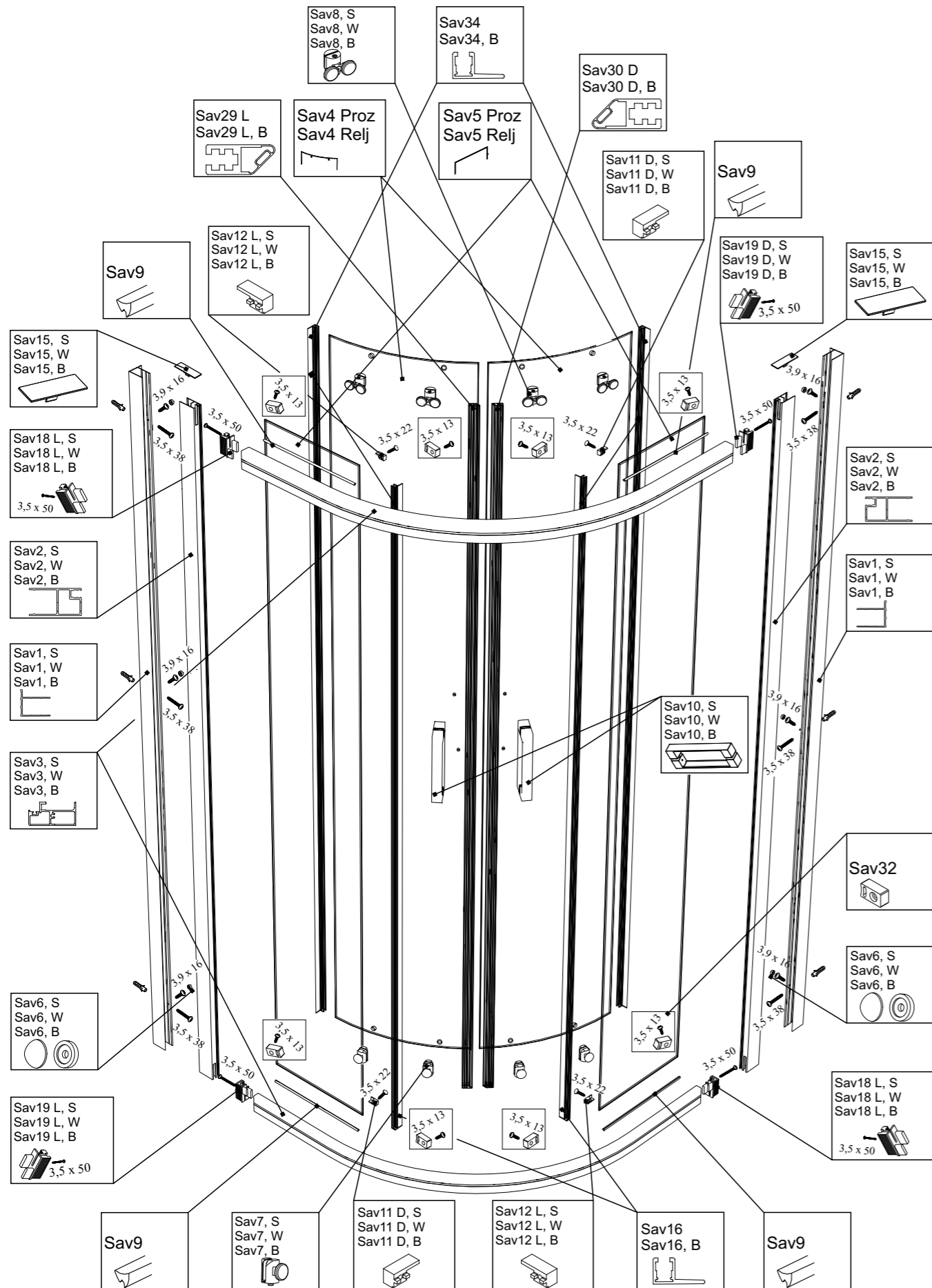

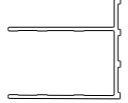
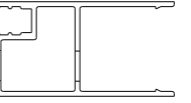
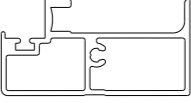
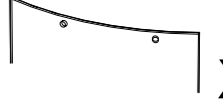
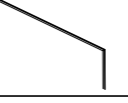
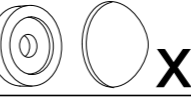
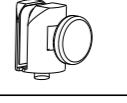
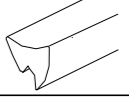

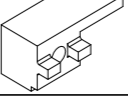
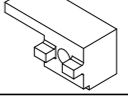

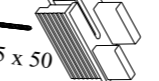

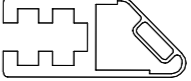
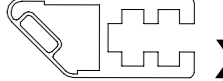
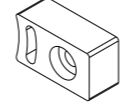
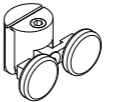
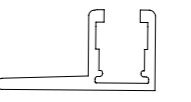



<p>Sav1, S Sav1, W Sav1, B</p>  <p>x2</p>	<p>Sav2, S Sav2, W Sav2, B</p>  <p>x2</p>	<p>Sav3, S Sav3, W Sav3, B</p>  <p>x2</p>	<p>Sav4 Proz Sav4 Relj</p>  <p>x2</p>		
<p>Sav5 Proz Sav5 Relj</p>  <p>x2</p>	<p>Sav6, S Sav6, W Sav6, B</p>  <p>x12</p>	<p>Sav7, S Sav7, W Sav7, B</p>  <p>x4</p>	<p>Sav8, S Sav8, W Sav8, B</p>  <p>x4</p>		
<p>Sav9</p>  <p>x4</p>	<p>Sav10, S Sav10, W Sav10, B</p>  <p>x2</p>	<p>Sav11 D, S Sav11 D, W Sav11 D, B</p>  <p>x2</p>	<p>Sav12 L, S Sav12 L, W Sav12 L, B</p>  <p>x2</p>		
<p>Sav13 L Sav13 L, B</p>  <p>x1</p>	<p>Sav14 D Sav14 D, B</p>  <p>x1</p>	<p>Sav15, S Sav15, W Sav15, B</p>  <p>x2</p>	<p>Sav16 Sav16, B</p>  <p>x4</p>		
<p>Sav18 L, S Sav18 L, W Sav18 L, B</p>  <p>x2</p>	<p>Sav19 D, S Sav19 D, W Sav19 D, B</p>  <p>x2</p>	<p>Sav32</p>  <p>x4</p>			
<p>Sav23</p>  <p> 3,9 x 16 3,5 x 13 3,5 x 22 Ø 6mm 3,5 x 38 4 mm </p> <p> 6 x 4 x 4 x 6 x 6 x 1 x </p>					



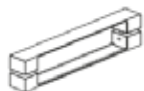

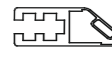
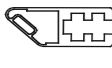

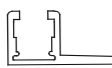

- | | | | |
|--|--|---|---|
| <p>Sav1, S
Sav1, W
Sav1, B</p>  <p>x1</p> | <p>Sav2, S
Sav2, W
Sav2, B</p>  <p>x1</p> | <p>Sav3, S
Sav3, W
Sav3, B</p>  <p>x2</p> | <p>Sav5 Proz
Sav5 Relj</p>  <p>x1</p> |
| <p>Sav6, S
Sav6, W
Sav6, B</p>  <p>x6</p> | <p>Sav9</p>  <p>x2</p> | <p>Sav15, S
Sav15, W
Sav15, B</p>  <p>x1</p> | <p>Sav18 L, S
Sav18 L, W
Sav18 L, B</p>  <p>x2</p> |
| <p>Sav19 D, S
Sav19 D, W
Sav19 D, B</p>  <p>x2</p> | <p>Sav24, S
Sav24, W
Sav24, B</p>  <p>x1</p> | | |
| <p>Sav25</p>  <p>3,9 x 16</p> <p>6 x</p> | | | |

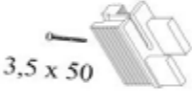

- | | | | |
|---|--|---|---|
| Sav1, S
Sav1, W
Sav1, B
 x2 | Sav2, S
Sav2, W
Sav2, B
 x2 | Sav3, S
Sav3, W
Sav3, B
 x2 | Sav4 Proz
Sav4 Relj
 x2 |
| Sav5 Proz
Sav5 Relj
 x2 | Sav6, S
Sav6, W
Sav6, B
 x12 | Sav7, S
Sav7, W
Sav7, B
 x4 | Sav9
 x4 |
| Sav10, S
Sav10, W
Sav10, B
 x2 | Sav11 D, S
Sav11 D, W
Sav11 D, B
 x2 | Sav12 L, S
Sav12 L, W
Sav12 L, B
 x2 | Sav15, S
Sav15, W
Sav15, B
 x2 |
| Sav18 L, S
Sav18 L, W
Sav18 L, B
 x2 | Sav19 D, S
Sav19 D, W
Sav19 D, B
 x2 | Sav29 L
Sav29 L, B
 x1 | Sav30 D
Sav30 D, B
 x1 |
| Sav32
 x8 | Sav33, S
Sav33, W
Sav33, B
 x4 | Sav34
Sav34, B
 x4 | |
| Sav31

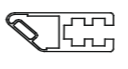
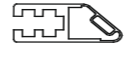
4 x 3,5 x 22 6 x 3,9 x 16 8 x 3,5 x 13 6 x Ø 6mm 6 x 3,5 x 38 1 x 4 mm | | | |

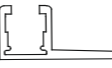





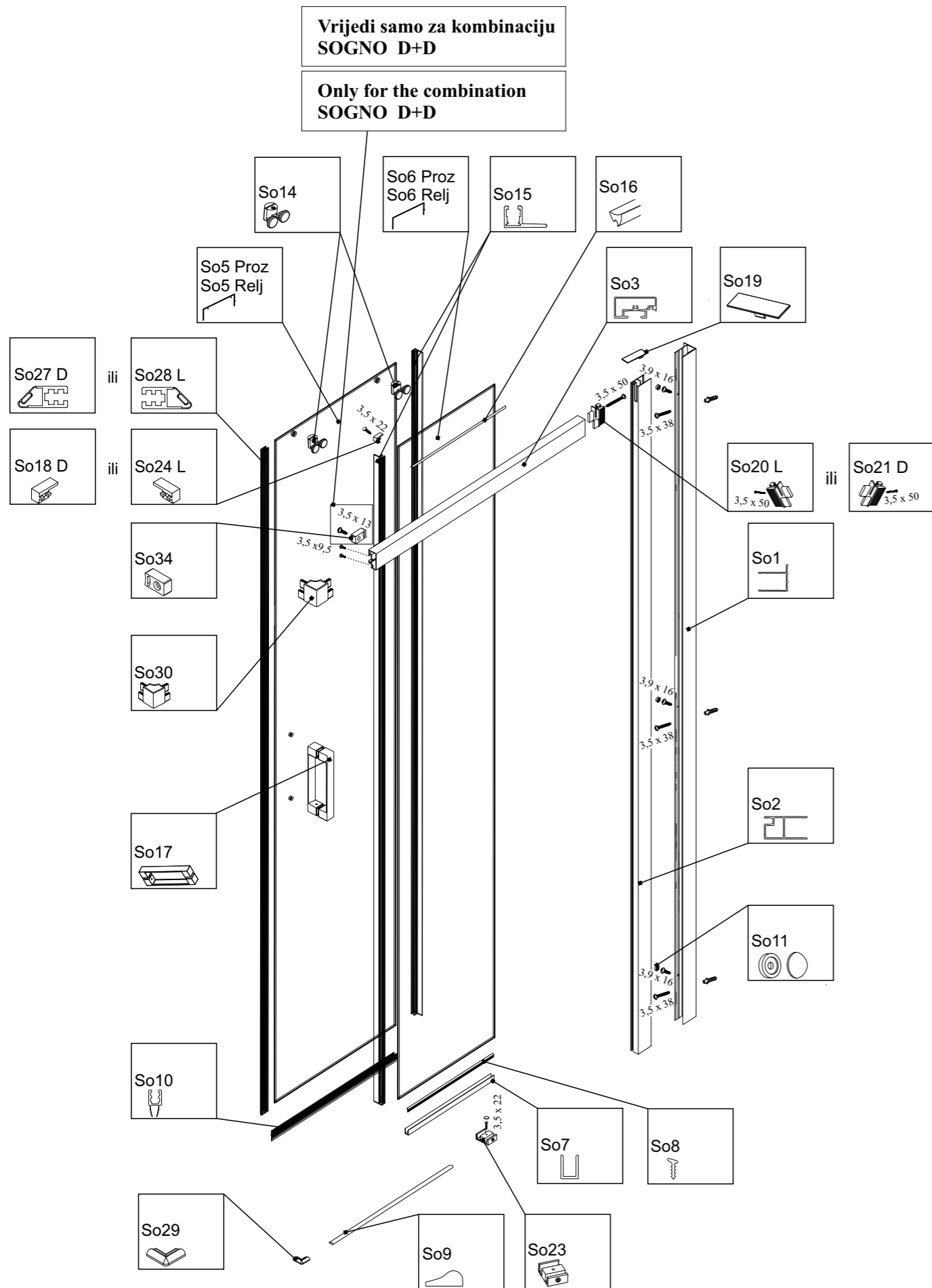



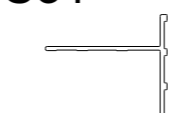
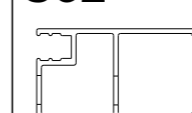
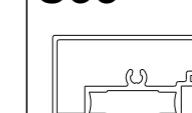
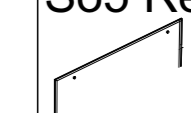

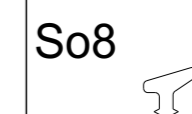

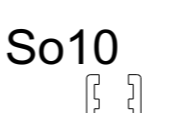
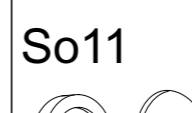

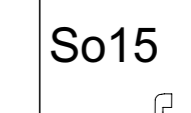
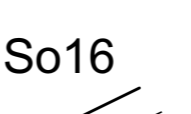

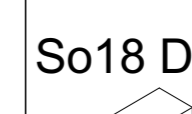
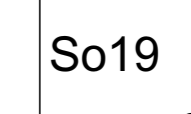

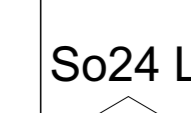

SAVANA / PANDORA	Specif. br.	Šifra	Opis
	Sav6, S Pa6, S	3113130	Ukrasna kapica s podloškom, siva
	Sav6, W Pa6, W	3113129	Ukrasna kapica s podloškom, bijela
	Sav6, B Pa6, B	3113131	Ukrasna kapica s podloškom, crna
	Sav7, S Pa7, S	3113162	Kotačić za Savanu, donji, sivi
	Sav7, W Pa7, W	3113160	Kotačić za Savanu, donji, bijeli
	Sav7, B Pa7, B	3113090	Kotačić za Savanu, donji, crni
	Sav8, S Pa8, S	3113019	Kotačić za Savanu, gornji, sivi - dupli
	Sav8, W Pa8, W	3113018	Kotačić za Savanu, gornji, bijeli - dupli
	Sav8, B Pa8, B	3113089	Kotačić za Savanu, gornji, crni - dupli
	Sav9 Pa9	3112004	PVC profil F60 vertikalni za profil TS-4175, proz., L=1000 mm
	Sav10, W Pa10, W	3113055	Ručke za tuš kabinu cod. 1015 - bijela
	Sav10 Pa10	3113054	Ručke za tuš kabinu cod. 1015 - chrom
	Sav10, B Pa10, B	3113096	Ručke za tuš kabinu cod. 1015 - crna mat
	Sav11 D, S Pa11 D, S	3113223	Plastika za učvršćenje fix. stakla - D, chrom
	Sav11 D, W Pa11 D, W	3113218	Plastika za učvršćenje fix. stakla - D, bijela
	Sav11 D, B Pa11 D, B	3113274	Plastika za učvršćenje fix. stakla - D, crna
	Sav12 L, S Pa12 L, S	3113222	Plastika za učvršćenje fix. stakla - L, chrom
	Sav12 L, W Pa12 L, W	3113217	Plastika za učvršćenje fix. stakla - L, bijela
	Sav12 L, B Pa12 L, B	3113273	Plastika za učvršćenje fix. stakla - L, crna
	Sav13 L	3112083	PVC profil mag M 126 L, V6 L=2000 mm, transp.sivi mag
	Sav13 L, B	3112094	PVC profil mag M 126 L, V6 L=2000 mm, crna
	Sav14 D	3112084	PVC profil mag M 126 D, V6 L=2000 mm, transp.sivi mag
	Sav14 D, B	3112093	PVC profil mag M 126 D, V6 L=2000 mm, crna
	Sav15, S Pa15, S	3113205	Poklopac za zid. prof. Savana, Galaxy, Sogno - sivi
	Sav15, W Pa15, W	3113204	Poklopac za zid. prof. Savana, Galaxy, Pandora - bijeli
	Sav15, B Pa15, B	3113270	Poklopac za zidni profil Savana, Pandora - crni
	Sav16	3112015	PVC profil E-503 V6, L=1990mm azurna, za staklo 6 mm
	Sav16, B	3113305	PVC profil G 013 V5-6, L=1985 mm, crna, pero 14 mm
	Pa16	3112015	PVC profil E-503 V6, L=1990mm azurna, za staklo 6 mm
	Pa16, B	3113305	PVC profil G 013 V5-6, L=1985 mm, crna, pero 14 mm
	Sav17, S Pa17, S	3113224	Spojna kutna plastika za profil E-15484, chrom
	Sav17, W Pa17, W	3113219	Spojna kutna plastika za profil E-15484, bijela
	Sav17, B Pa17, B	3113275	Spojna kutna plastika za profil E-15484, crna

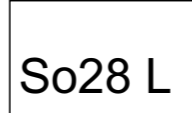
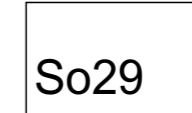
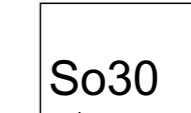
SAVANA / PANDORA	Specif. br.	Šifra	Opis
	Sav18 L, S Pa18 L, S	3113220	Spojna plastika luk-vert. profil - L, chrom
	Sav18 L, W Pa18 L, W	3113215	Spojna plastika luk-vert. profil - L, bijela
	Sav18 L, B Pa18 L, B	3113271	Spojna plastika luk-vert. profil - L, crna
	Sav19 D, S Pa19 D, S	3113221	Spojna plastika luk-vert. profil - D, chrom
	Sav19 D, W Pa19 D, W	3113216	Spojna plastika luk-vert. profil - D, bijela
	Sav19 D, B Pa19 D, B	3113272	Spojna plastika luk-vert. profil - D, crna
	Sav22 Pa22	3112014	PVC profil mag. M 112 V6 L=1985 mm, transp. sivi mag
	Sav22, B Pa22, B	3113307	PVC profi mag M 112, V6 L=2000 mm, crni
	Sav26 Pa26	3112073	PVC profil ART.TP145/83, transparent, L=2000 mm
	Sav27 Pa27	3112056	PVC profil mag. 31M, L=2000 mm, siva – Saturno
	Sav27, B Pa27, B	3112008	PVC profil mag. M 032, L=2000 mm, crni 9011
	Sav29 L	3112057	PVC profil mag. M 121 L, V4 L=1990 mm transp. sivi mag
	Sav29 L, B	3113303	PVC profi mag M 121 L, V4 L=1990 mm, crna
	Sav30 D	3112058	PVC profil mag. M 121 D, V4 L=1990 mm transp. sivi mag
	Sav30 D, B	3113304	PVC profi mag M 121 D, V4 L=1990 mm, crni
	Sav32 Pa29	3113091	Stoperi/graničnici za kotačiće, transparent
	Sav33, S	6100200	Kotačić za Savanu poluk., gornji dupli, silver
	Sav33, W	6100199	Kotačić za Savanu poluk., gornji dupli, bijela
	Sav33, B	6100201	Kotačić za Savanu poluk., gornji dupli, crna mat
	Sav34	6100211	PVC profil E-503 V6, L=1985 mm azurna, za staklo 5 mm
	Sav34, B	3113305	PVC profil G 013 V5-6, L=1985 mm, crna, pero 14 mm

Vrijedi samo za kombinaciju SOGNO D+D

Only for the combination SOGNO D+D

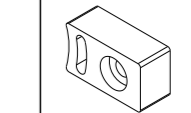

So1  x1	So2  x1	So3  x1	So5 Proz So5 Relj  x1
So6 Proz So6 Relj  x1	So7  x1	So8  x1	So9  x1
So10  x1	So11  x3	So14  x2	So15  x2
So16  x1	So17  x1	So18 D  x1	So19  x1
So20 L  x1	So21 D  x1	So23  x1	So24 L  x1
So27 D  x1	So28 L  x1	So29  x1	So30  x1
So31  2 x  3 x  1 x  2 x  3 x  3 x  1 x			So34  x1

* Vrijedi samo za kombinaciju SOGNO D+D

Only for the combination SOGNO D+D

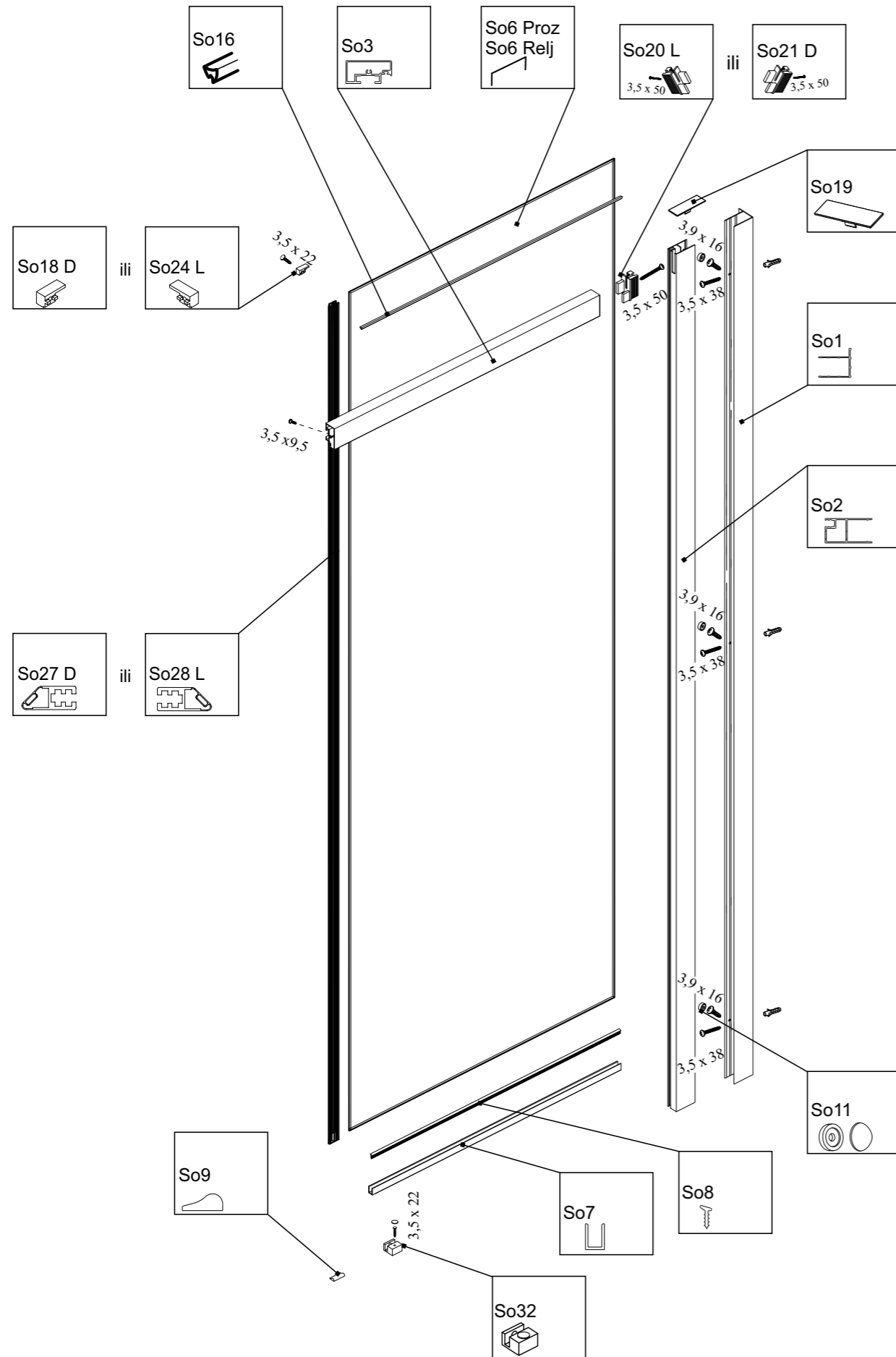



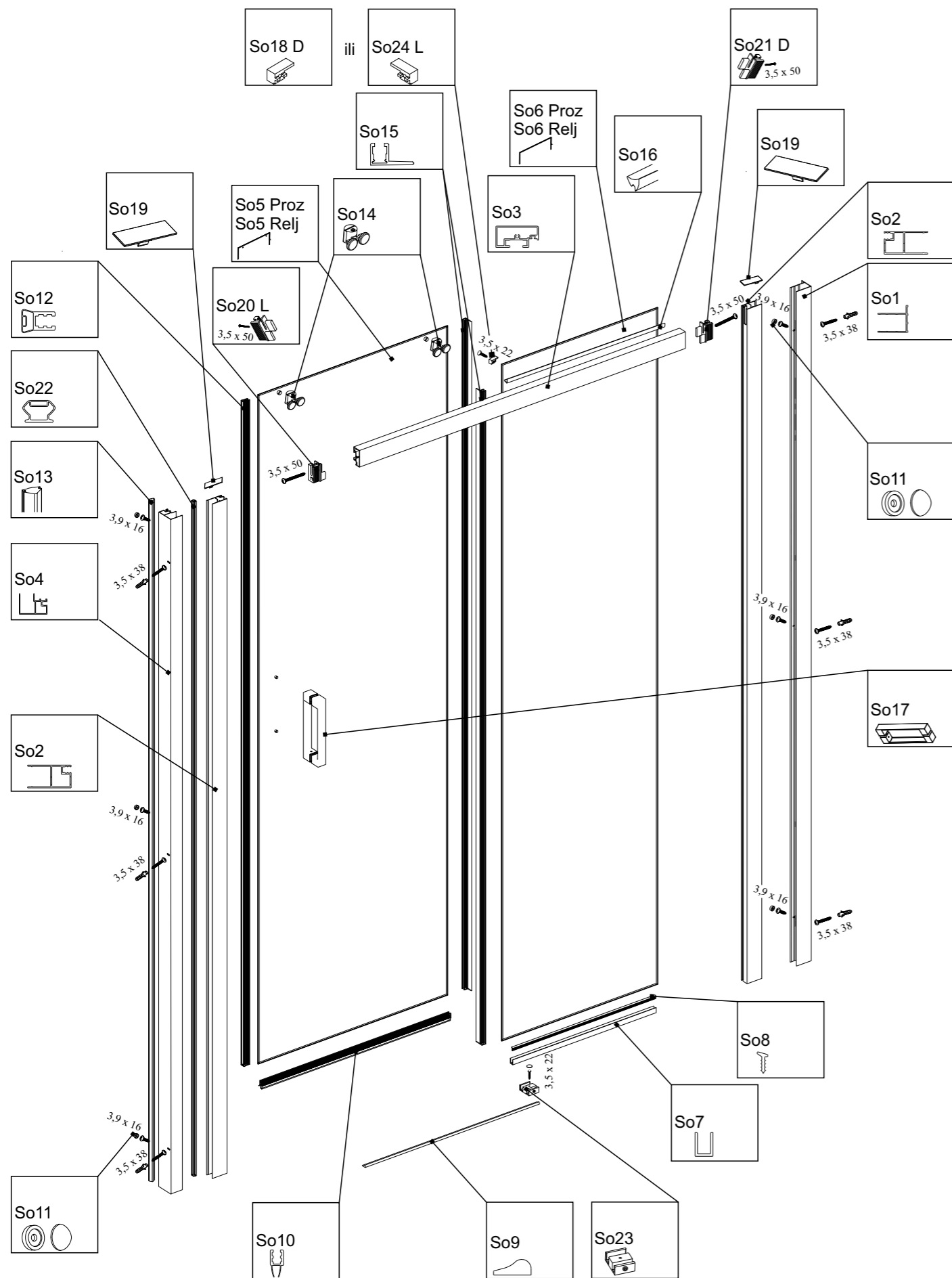



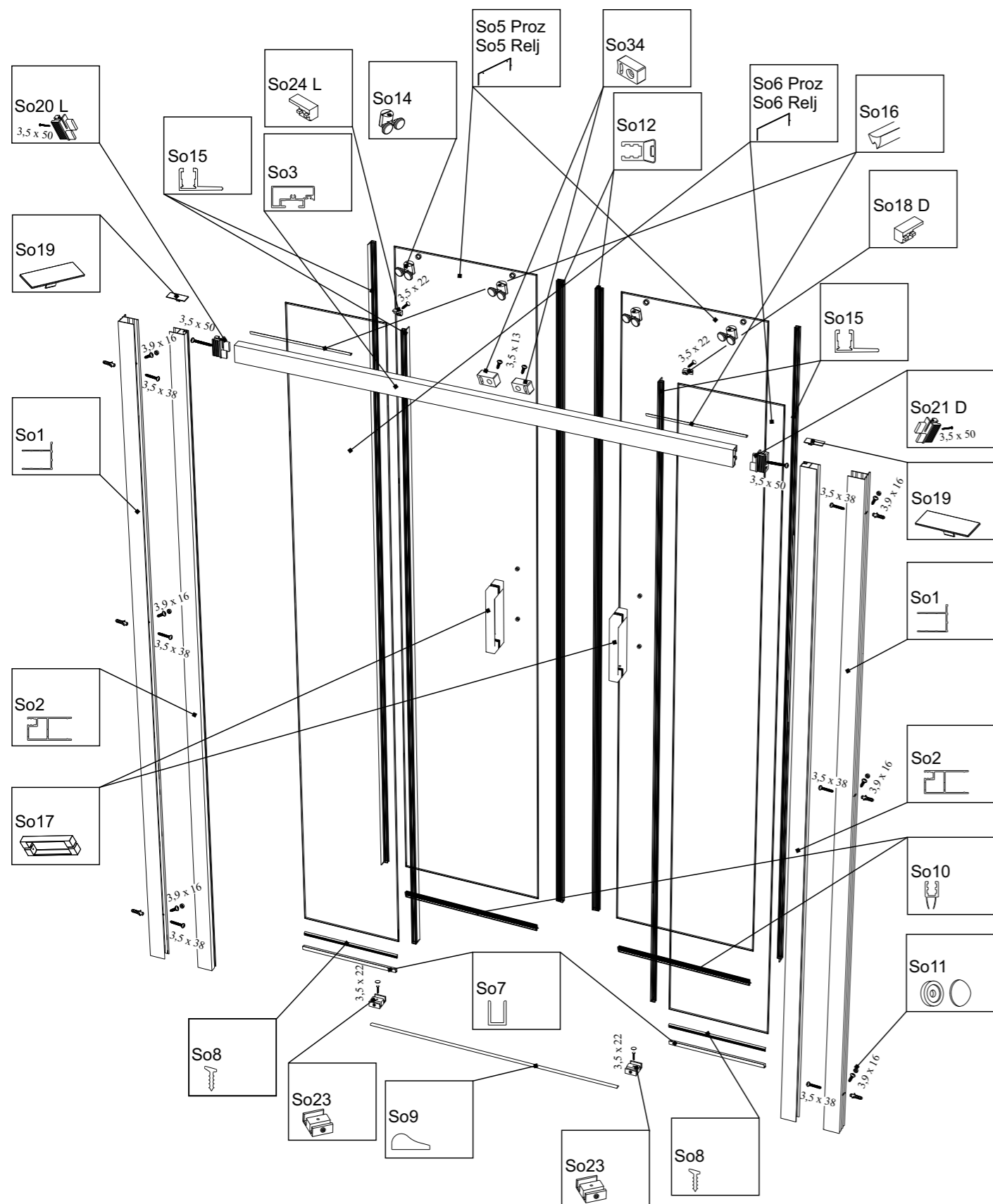

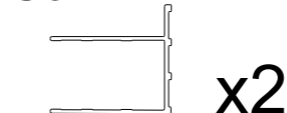
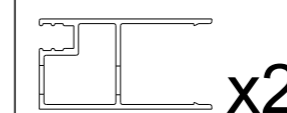
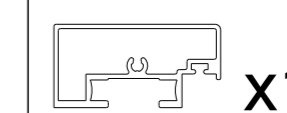
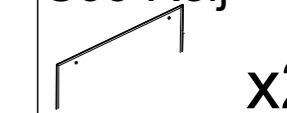





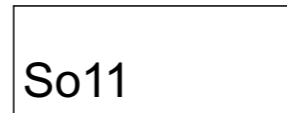
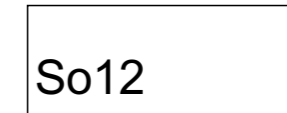
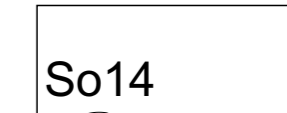
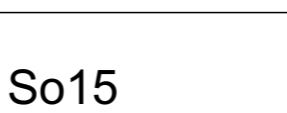
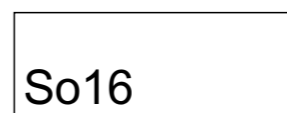

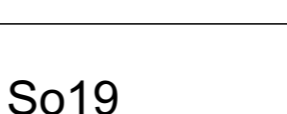
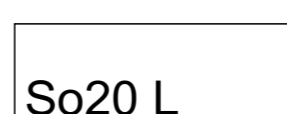
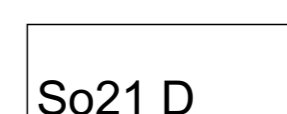

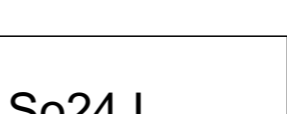
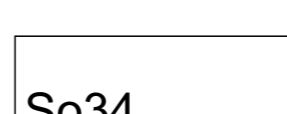
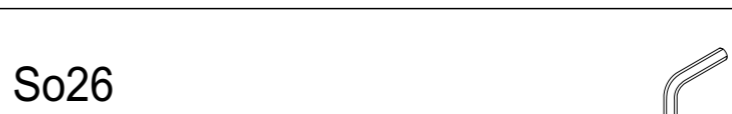







- | | | | |
|---|--------------|--------------|----------------------------|
| So1
x1 | So2
x1 | So3
x1 | So6 Proz
So6 Relj
x1 |
| So7
x1 | So8
x1 | So9
x1 | So11
x3 |
| So16
x1 | So18 D
x1 | So19
x1 | So20 L
x1 |
| So21 D
x1 | So24 L
x1 | So27 D
x1 | So28 L
x1 |
| So32
x1 | | | |
| <p>So33</p> <p> 1 x 3 x 2 x 3 x 3 x </p> | | | |



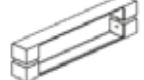

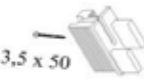

So1  x1	So2  x2	So3  x1	So4  x1
So5 Proz So5 Relj  x1	So6 Proz So6 Relj  x1	So7  x1	So8  x1
So9  x1	So10  x1	So11  x6	So12  x1
So13  x1	So14  x2	So15  x2	So16  x1
So17  x1	So18 D  x1	So19  x2	So20 L  x1
So21 D  x1	So22  x1	So23  x1	So24 L  x1
So25  3,9 x 16  3,5 x 22  Ø 6mm  3,5 x 38  4 mm 6x 2x 6x 6x 1x			

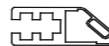

So1  x2	So2  x2	So3  x1	So5 Proz So5 Relj  x2
So6 Proz So6 Relj  x2	So7  x2	So8  x2	So9  x1
So10  x2	So11  x12	So12  x2	So14  x4
So15  x4	So16  x2	So17  x2	So18 D  x1
So19  x2	So20 L  x1	So21 D  x1	So23  x2
So24 L  x1	So34  x2	So26  4 x 2 x 6 x 6 x 6 x 1 x	

SOGNO	Specif. br.	Šifra	Opis
	So7	6100035	Alu. profil U 15x11x15, L=1000 mm, silver
	So8	3112024	PVC profil F60/2 vertikalni za profil E-8854,prozi, L=1000 mm
	So9	6100025	Podni brtveni Alu. profil L=1000 mm, silver
	So10	6100079	PVC profil G 026 V6, L=2400mm, pera 10 mm - Sogno
	So11	3113130	Ukrasna kapica s podloškom, siva
	So12	3112014	PVC profil mag. M 112 V6 L=1985m,m transp. sivi mag
	So13	3112073	PVC profil ART.TP145/83, transparent, L=2000 mm
	So14	3113019	Kotačić za Savanu, gornji, sivi - dupli
	So15	3112015	PVC profil E-503 V6, L=1990 mm azurna, za staklo 6 mm
	So16	3112004	PVC profil F60 vertikalni za profil TS-4175, prozirna, L=1000 mm
	So17	3113054	Ručke za tuš kabinu cod. 1015 - chrom
	So18 D	3113223	Plastika za učvršćenje fix. stakla - D, chrom
	So19	3113205	Poklopac za zid. prof. Savana, Galaxy, Sogno - sivi
	So20 L	3113220	Spojna plastika luk-vert. profil - L, chrom
	So21 D	3113221	Spojna plastika luk-vert. profil - D, chrom
	So22	3112056	PVC profil mag. 31M, L=2000 mm, sivi – Saturno
	So23	3113044	Sogno vodilica, 32x40 mm, inox
	So24 L	3113222	Plastika za učvršćenje fix. stakla - L, chrom



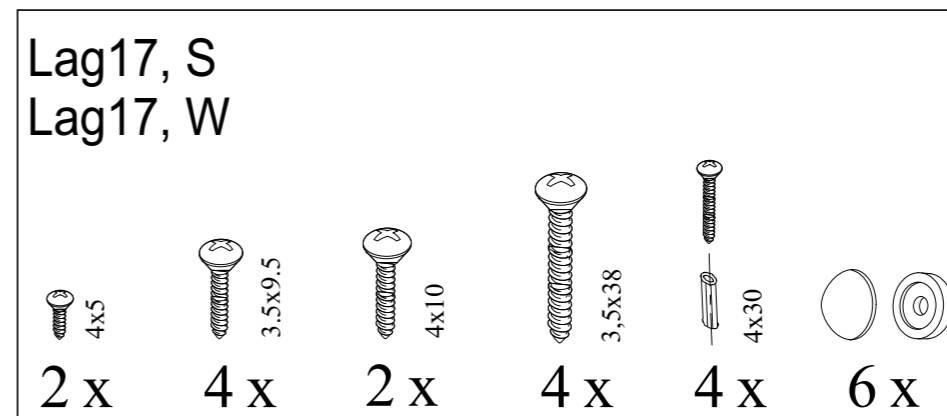
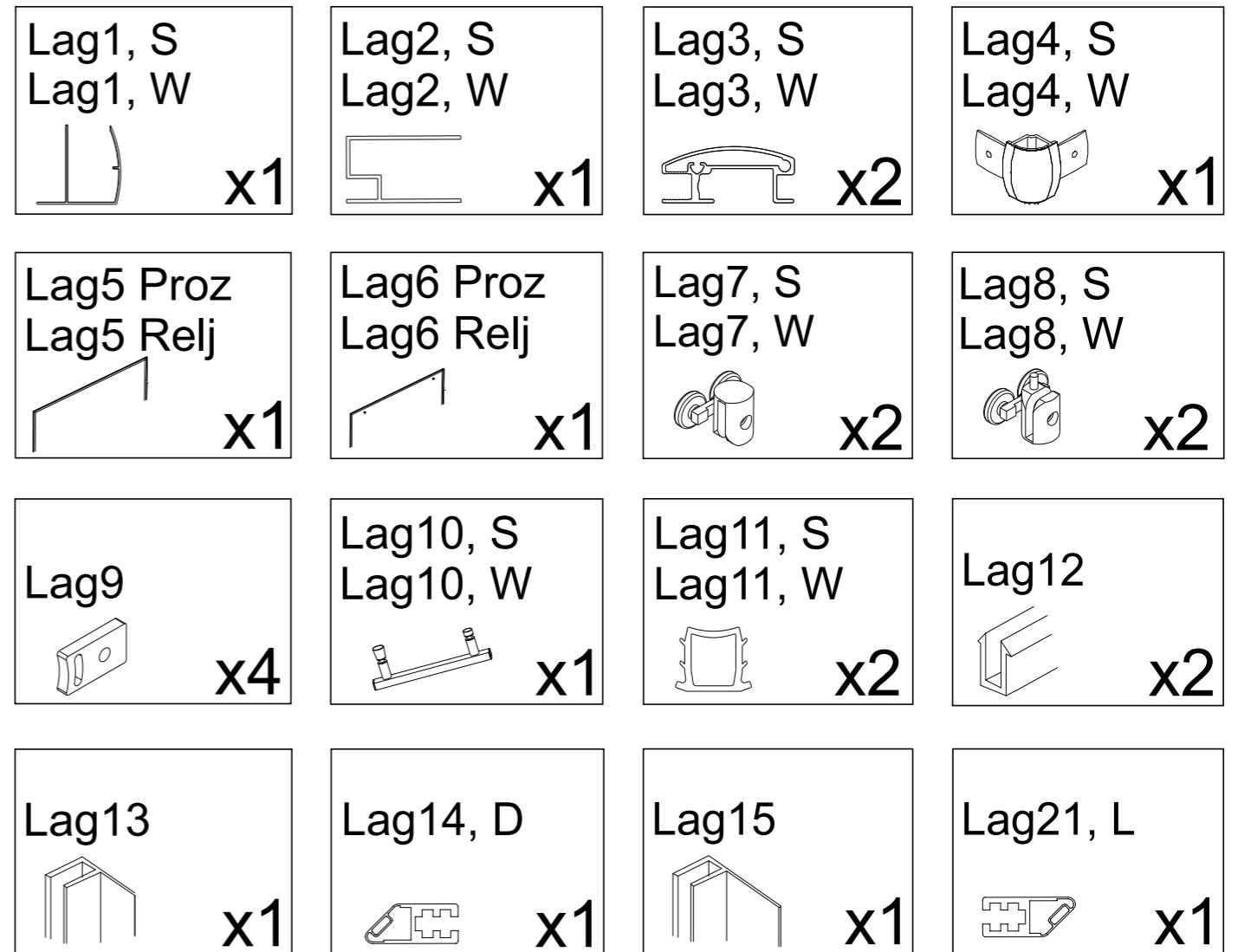
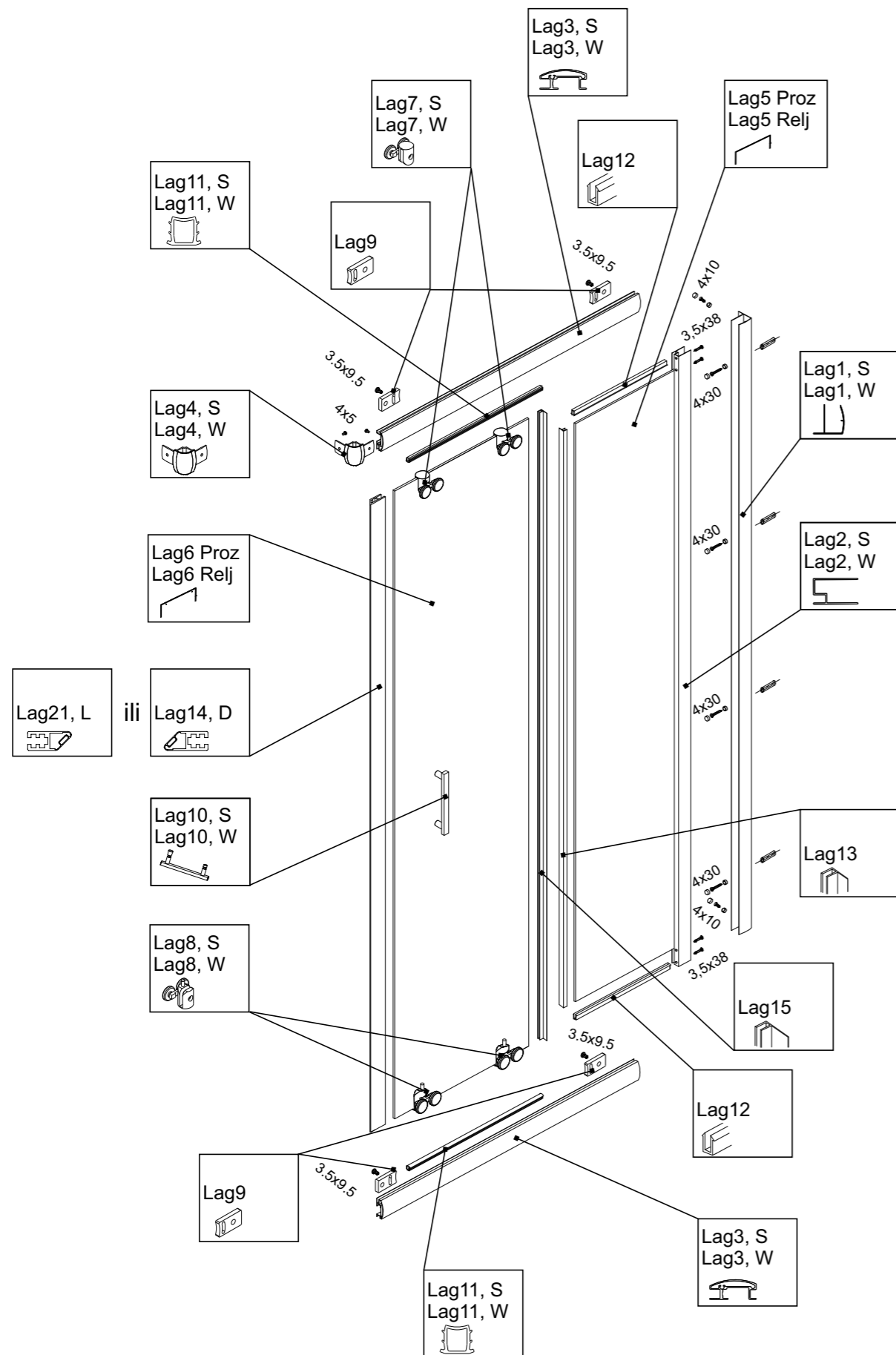

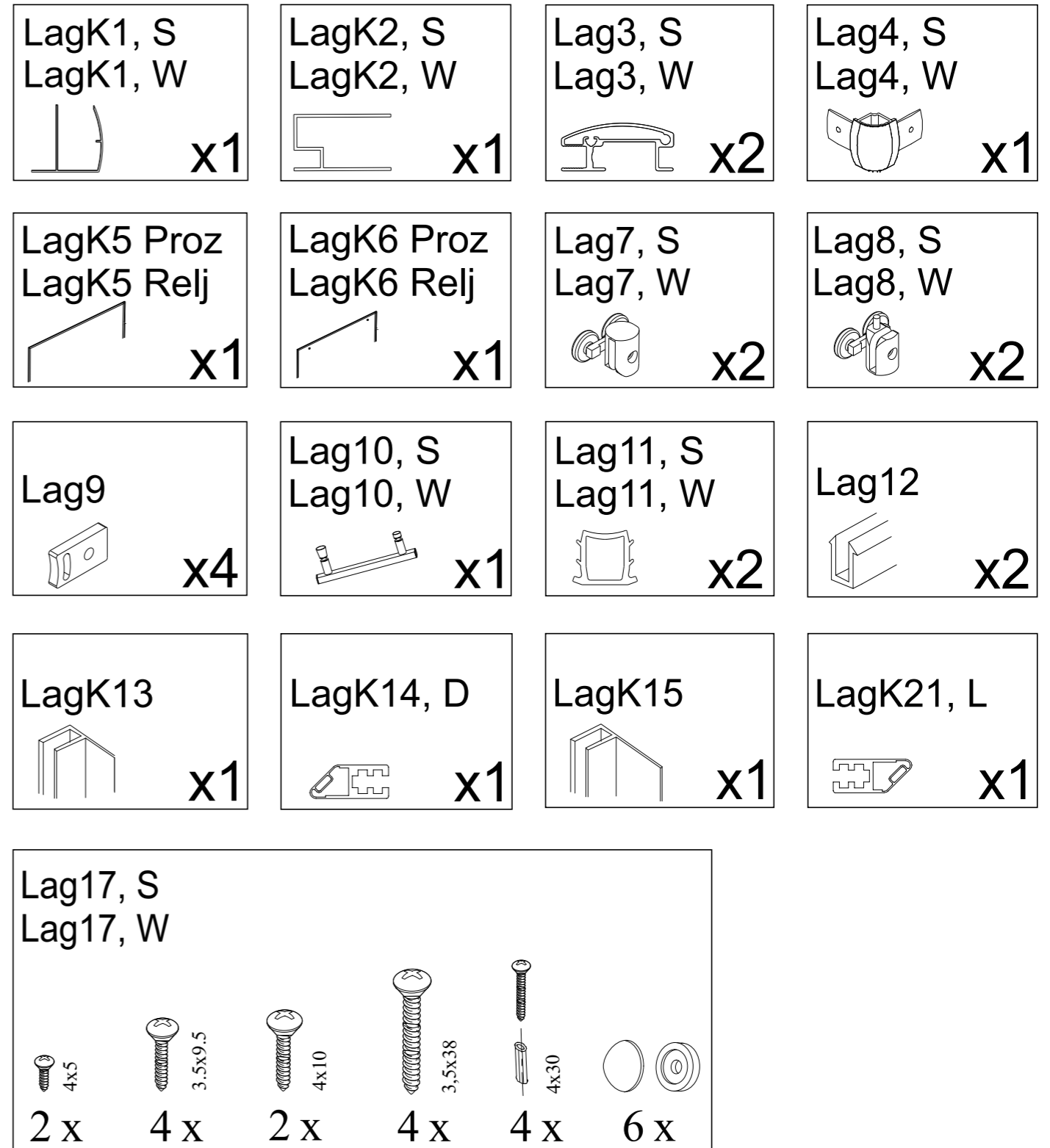
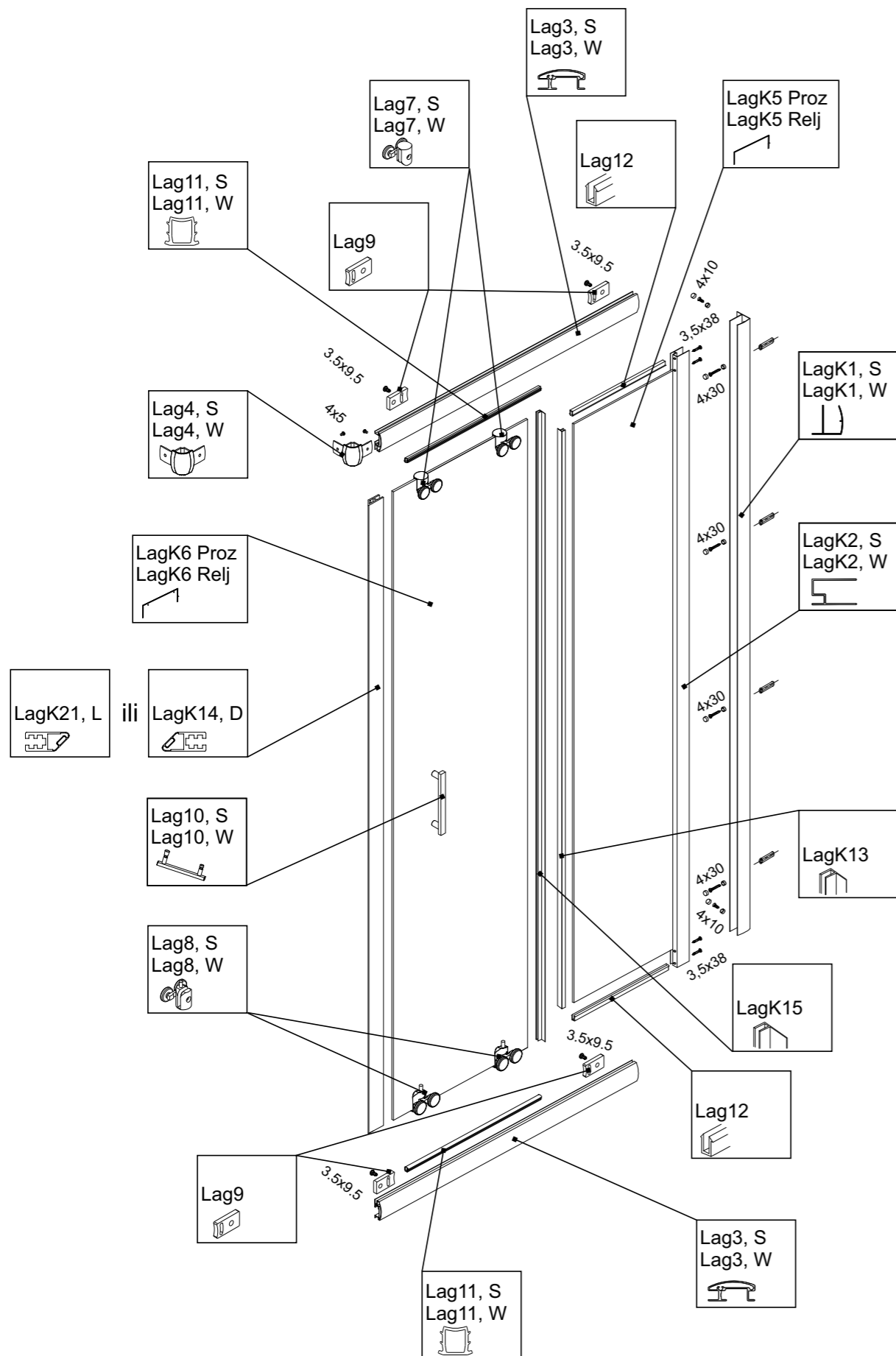

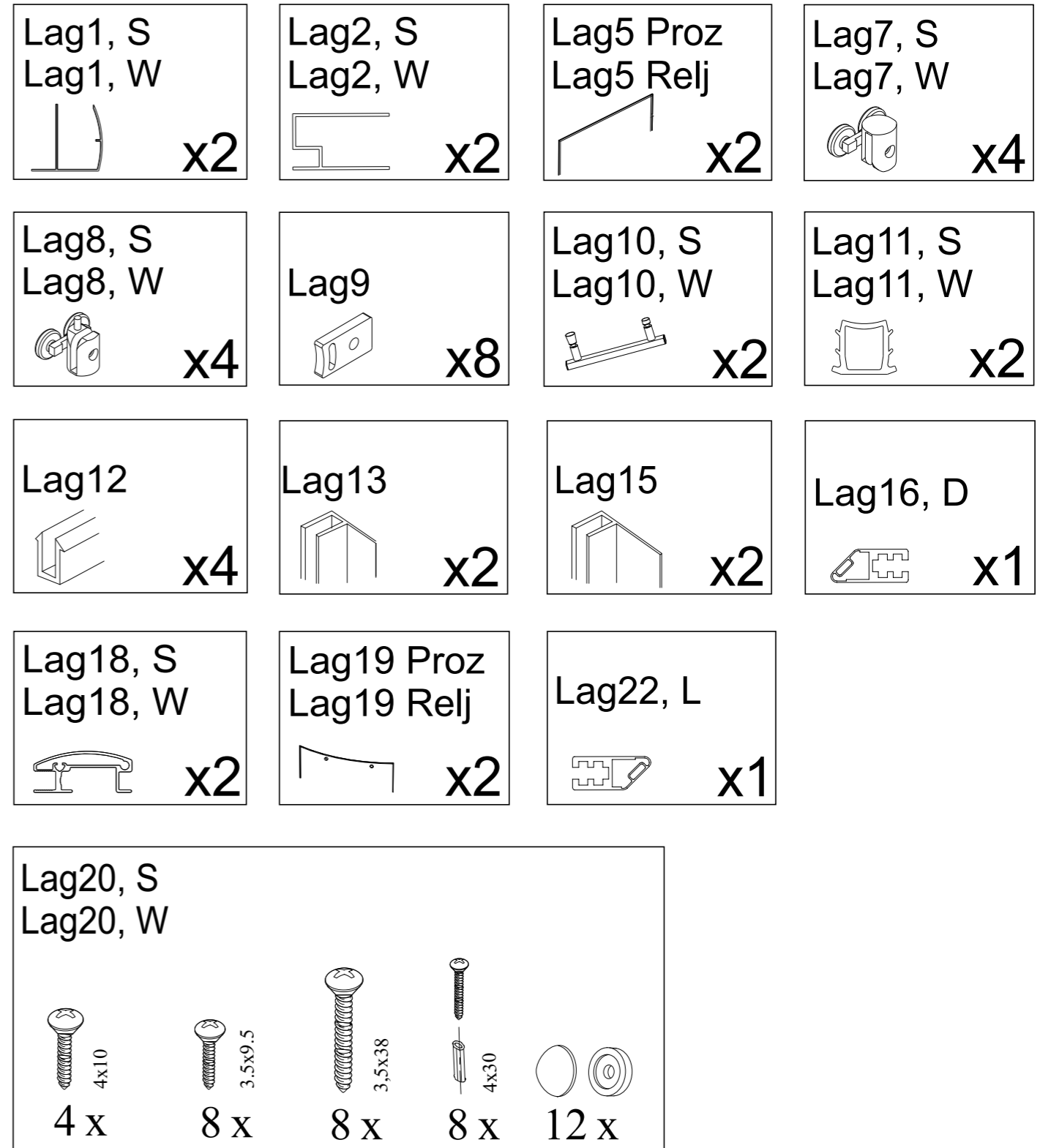
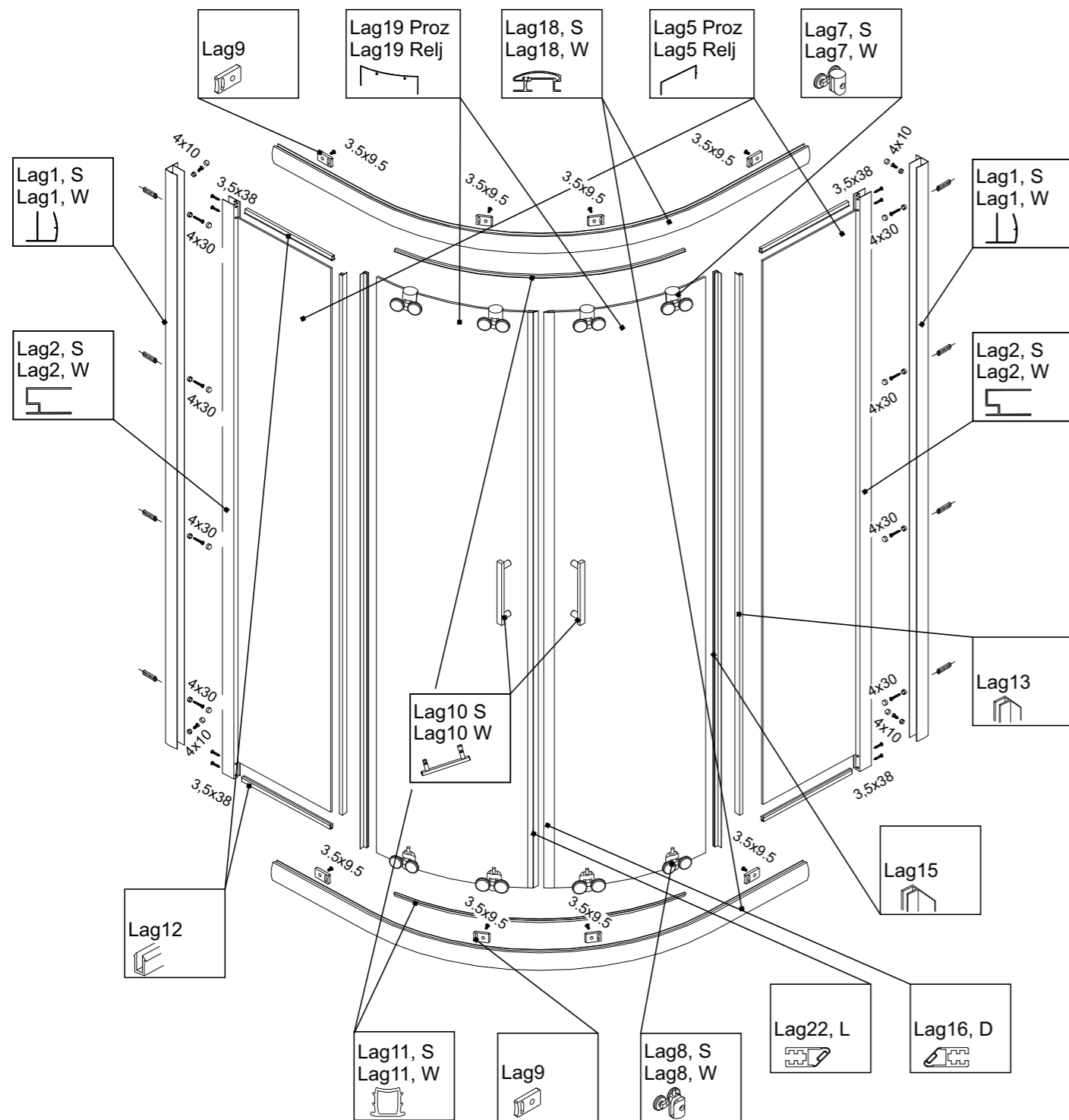

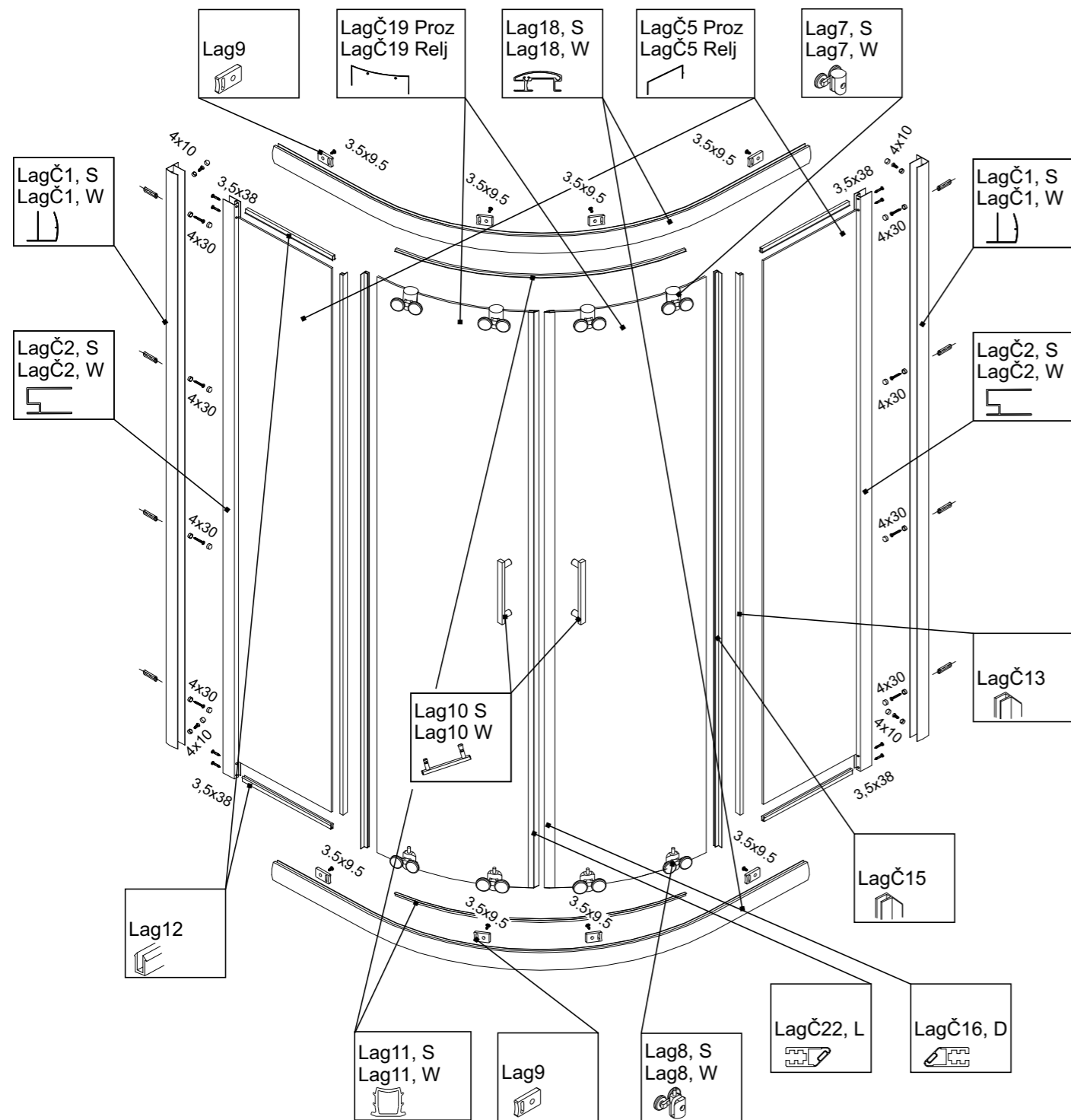

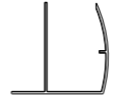
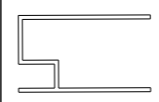

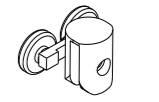
SOGNO	Specif. br.	Šifra	Opis
	So27 D	3112084	PVC profil mag. M 126 D, V6 L=2000 mm, transp. sivi mag
	So28 L	3112083	PVC profil mag. M 126 L, V6 L=2000 mm, transp. sivi mag
	So29	3113016	Spojna plastika br. profil, Sigma, kutni
	So30	3113224	Spojna kutna plastika za profil E-15484, chrom
	So32	3113045	Aurora donji fiksator, 25x25 mm, inox
	So34	3113091	Stoperi/graničnici za kotačiće, transparent

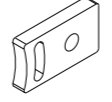
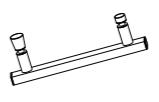

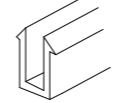

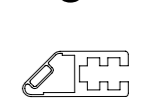
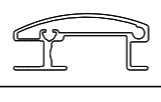
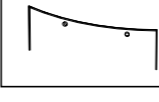
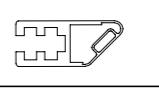

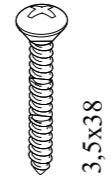
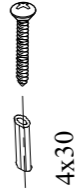











LagČ1, S LagČ1, W  x2	LagČ2, S LagČ2, W  x2	LagČ5 Proz LagČ5 Relj  x2	Lag7, S Lag7, W  x4
Lag8, S Lag8, W  x4	Lag9  x8	Lag10, S Lag10, W  x2	Lag11, S Lag11, W  x2
Lag12  x4	LagČ13  x2	LagČ15  x2	LagČ16, D  x1
Lag18, S Lag18, W  x2	LagČ19 Proz LagČ19 Relj  x2	LagČ22, L  x1	
Lag20, S Lag20, W  4x  8x  8x  8x  12x			



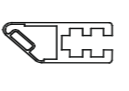

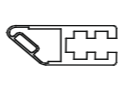
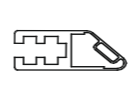
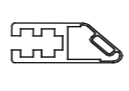

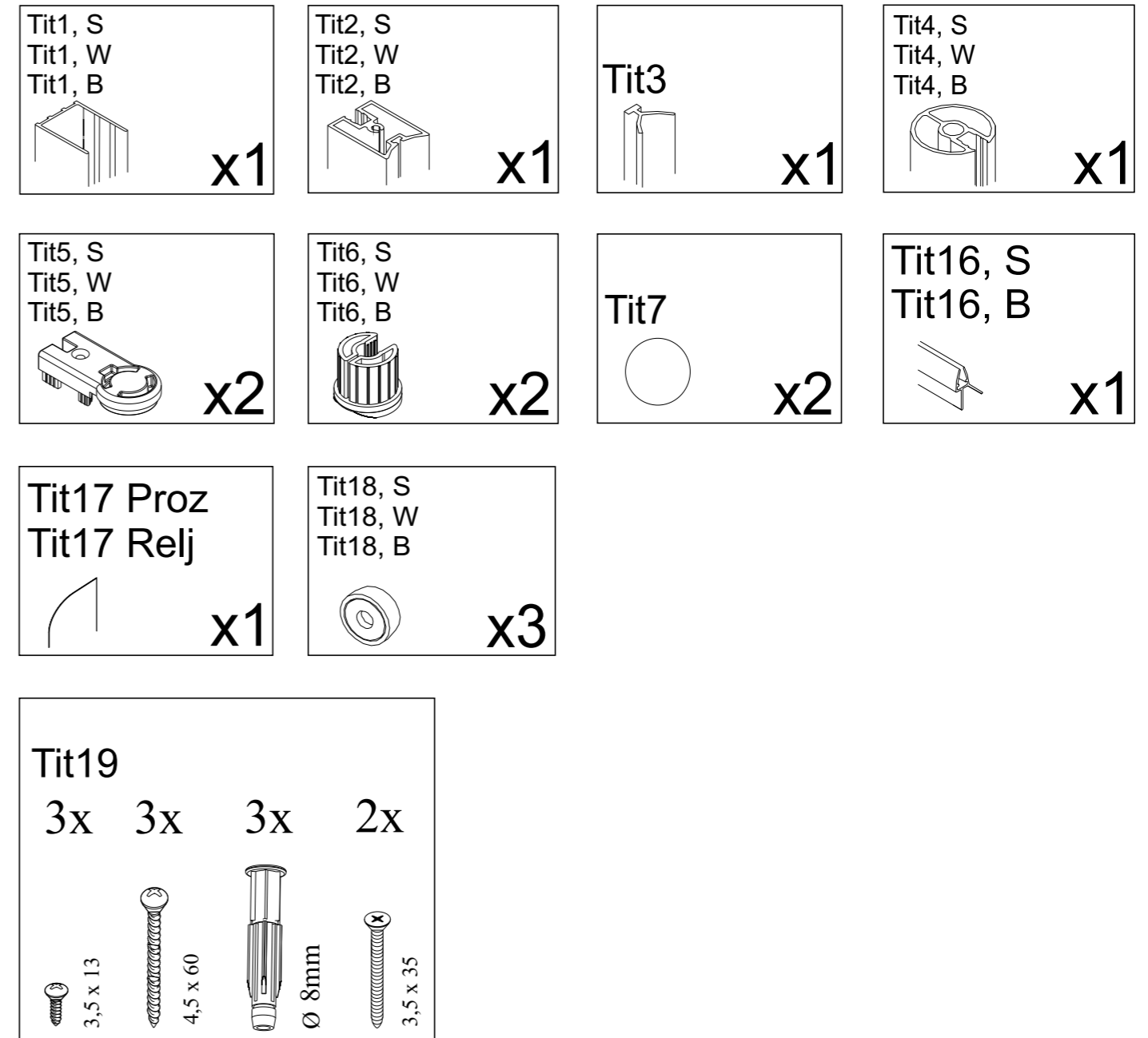
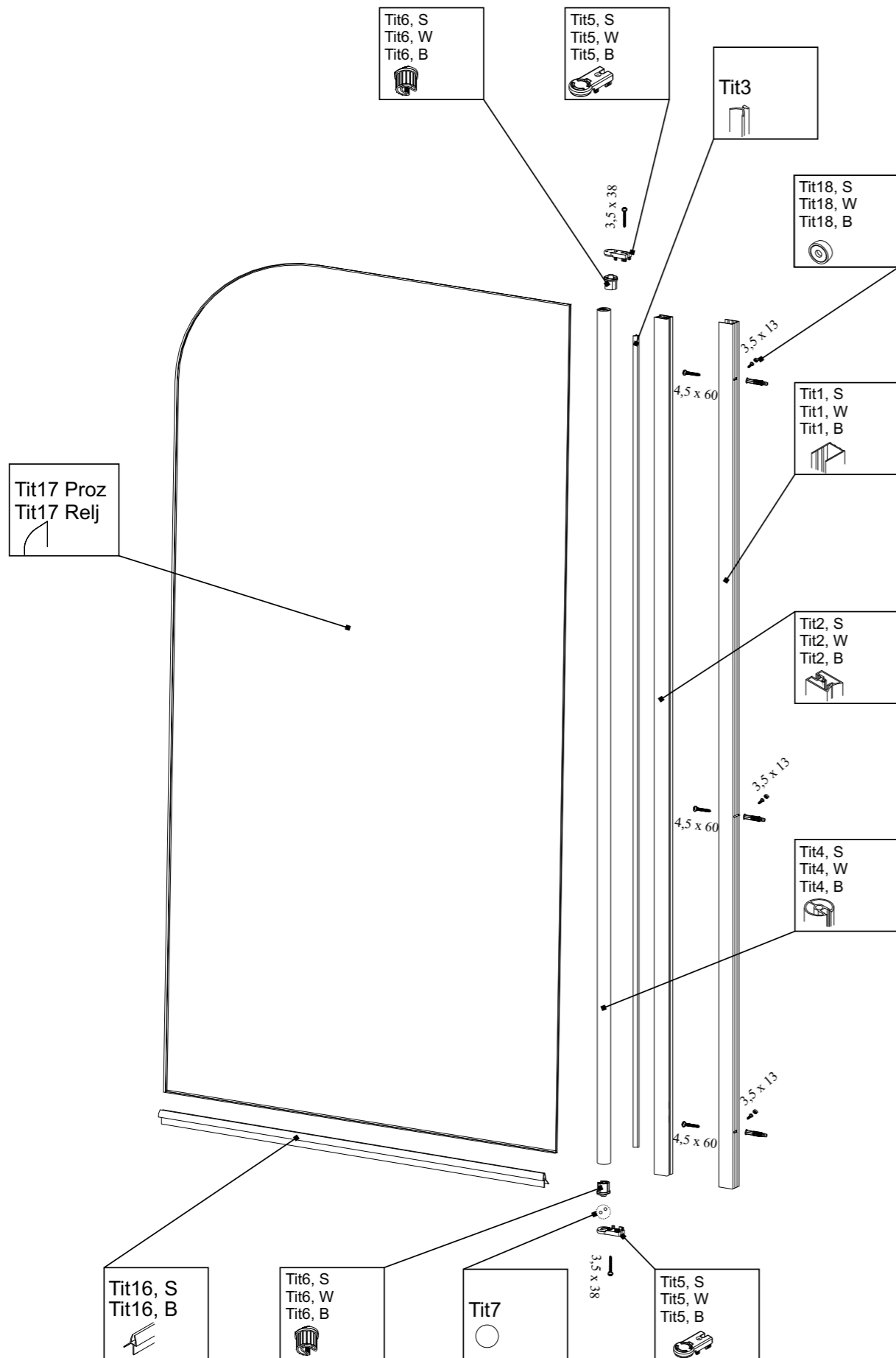

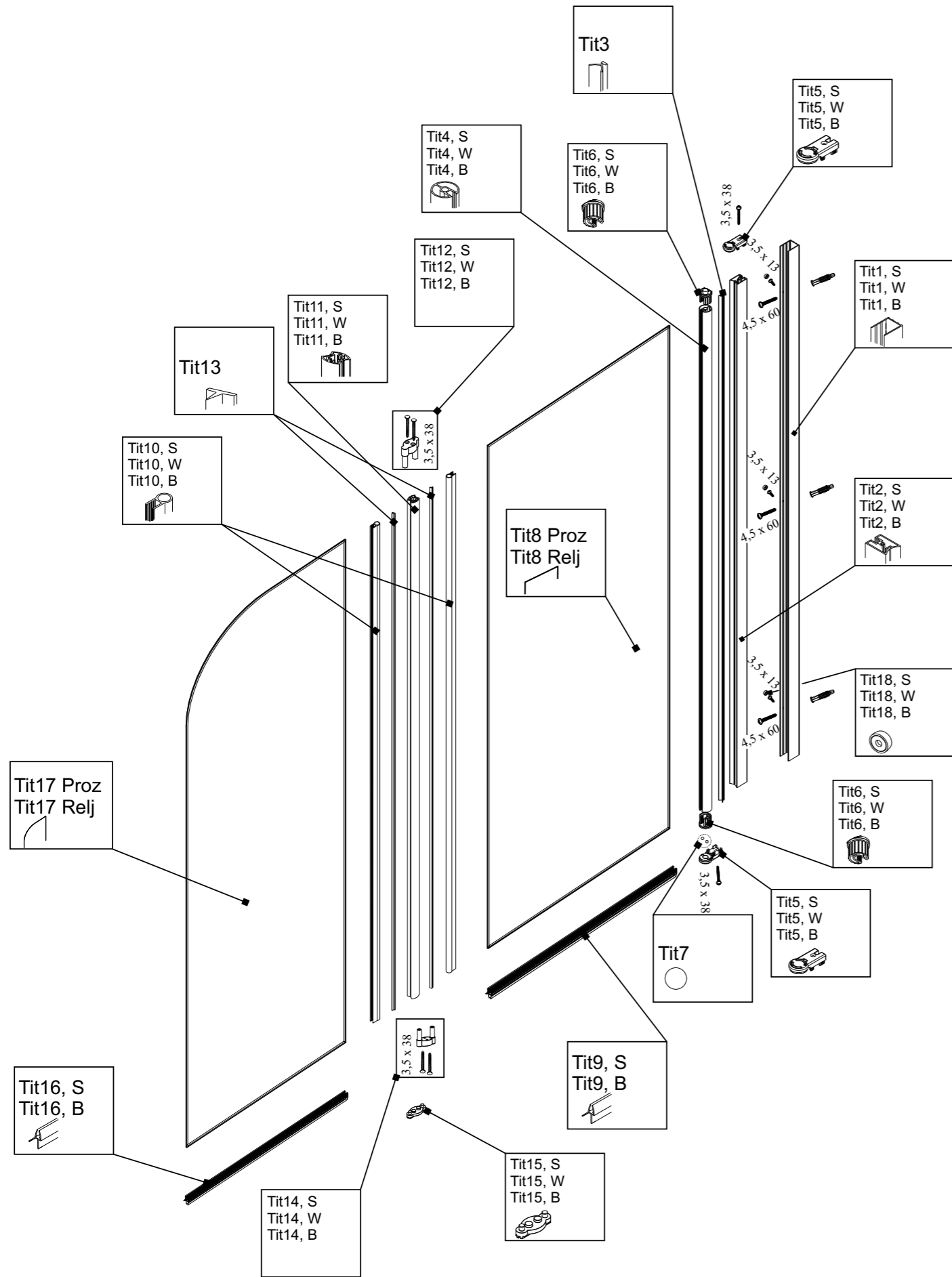

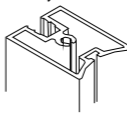
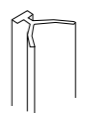
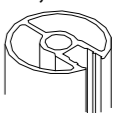
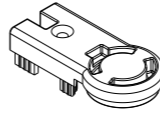
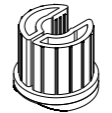
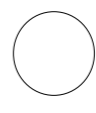

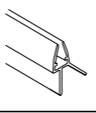
LAGUNA II

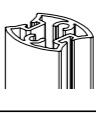
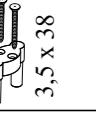
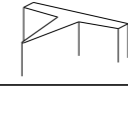
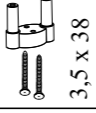
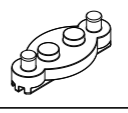
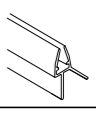



LAGUNA II	Specif. br.	Šifra	Opis
	Lag4, S	3113258	Spojni kutnik za Lagunu, silver
	Lag4, W	3113259	Spojni kutnik za Lagunu, bijeli
	Lag7, S	3113268	Kotačić gornji dupli, RLM02, sivi, za Lagunu II
	Lag7, W	3113276	Kotačić gornji dupli, RLM02, bijeli, za Lagunu II
	Lag8, S	3113269	Kotačić donji dupli, RLM02, sivi, za Lagunu II
	Lag8, W	3113277	Kotačić donji dupli, RLM02, bijeli, za Lagunu II
	Lag9	6100212	Stoper / graničnik za kotačić, transparent, Laguna II
	Lag10, S	3113061	Ručka za tuš paravan Laguna II, C11-C, chrom
	Lag10, W	3113062	Ručka za tuš paravan Laguna II, C11-W, bijela
	Lag11, S	3112066	PVC profil ukrasni, za vodilicu Laguna, prozirni, L=1000 mm
	Lag11, W	3112065	PVC profil ukrasni, za vodilicu Laguna, bijeli, L=1000 mm
	Lag12	3112061	PVC profil između stakla i vodilice, za Lagunu, L=1000 mm
	Lag13	3112001	PVC profil E-503 V6, L=1810 mm, azurna
	LagČ13		
	Lag14, D	3112051	PVC profil mag M122 D,V6, L=1870 mm azur.sivi mag
	LagK14, D		
	Lag15	3112002	PVC profil E-503 V6, L=1870 mm, azurna
	LagČ15		
	Lag16, D	3112058	PVC profi mag M 121 D,V4 L=1990 mm transp.sivi mag
	LagČ16, D		
	Lag21, L	3112031	PVC profil mag M122 L,V6, L=1870 mm azur.sivi mag
	LagK21, L		
	Lag22, L	3112057	PVC profi mag M 121 L,V4 L=1990 mm transp.sivi mag
	LagČ22, L		

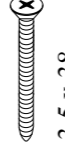

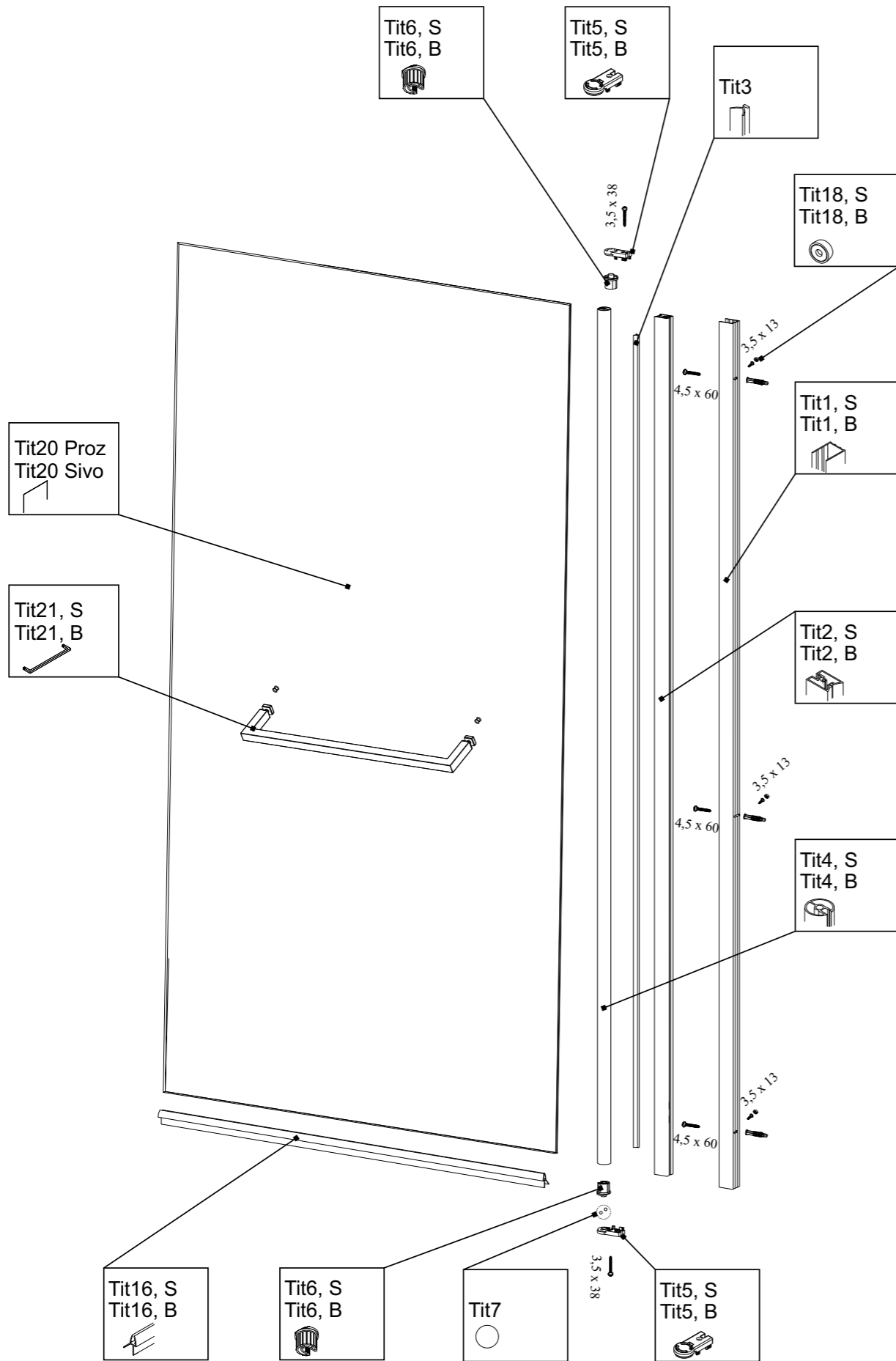

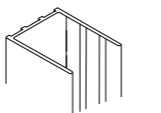
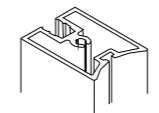
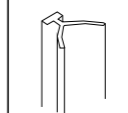
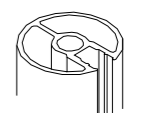
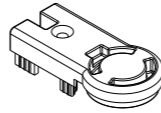
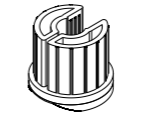

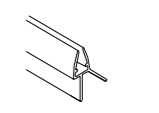

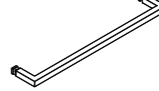
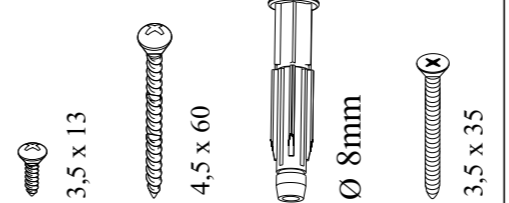

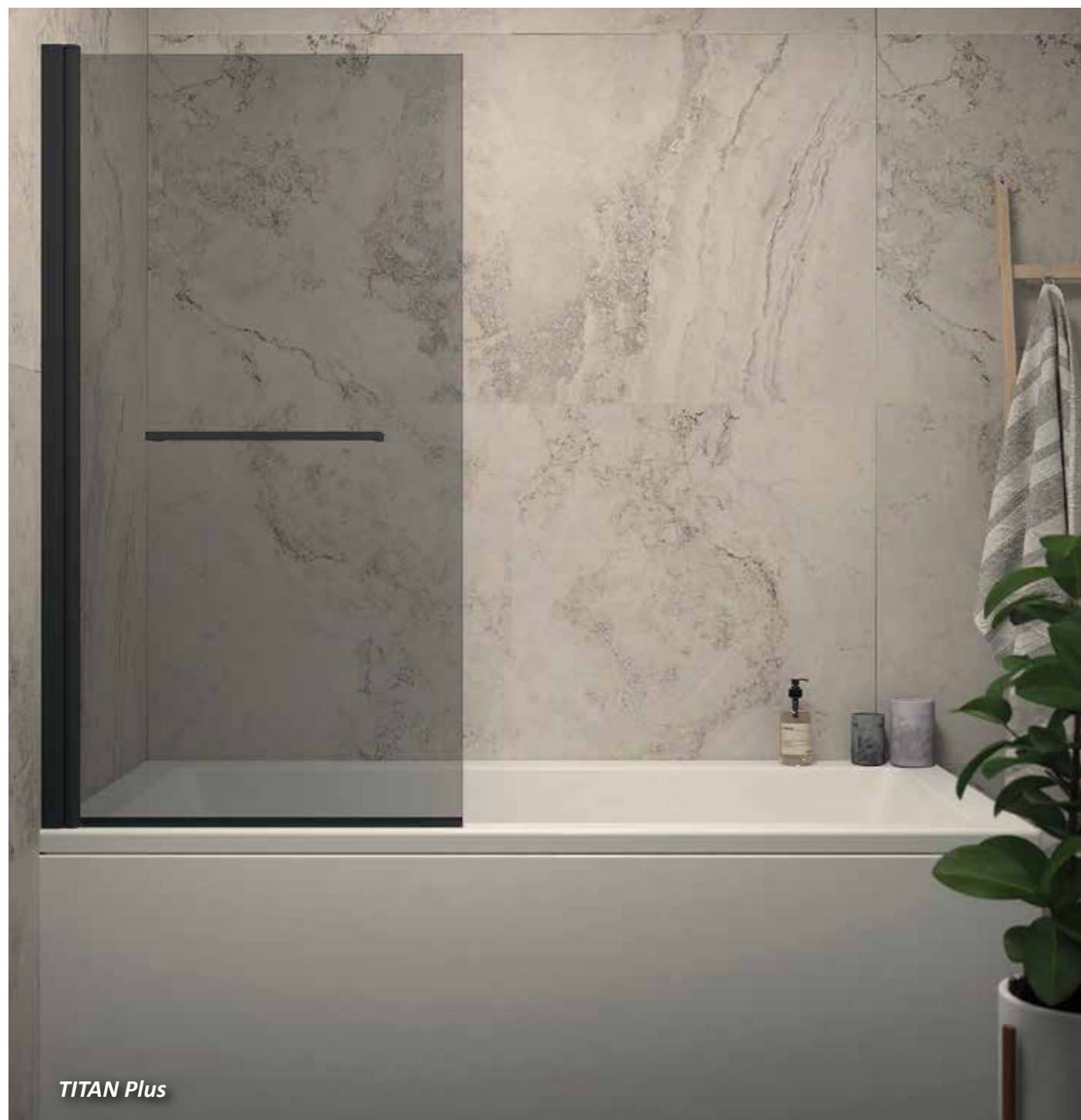

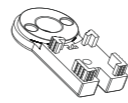
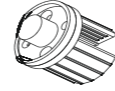

- | | | | |
|---|--|--|--|
| Tit1, S
Tit1, W
Tit1, B
 x1 | Tit2, S
Tit2, W
Tit2, B
 x1 | Tit3
 x1 | Tit4, S
Tit4, W
Tit4, B
 x1 |
| Tit5, S
Tit5, W
Tit5, B
 x2 | Tit6, S
Tit6, W
Tit6, B
 x2 | Tit7
 x2 | Tit8 Proz
Tit8 Relj
 x1 |
| Tit9, S
Tit9, B
 x1 | Tit10, S
Tit10, W
Tit10, B
 x2 | Tit11, S
Tit11, W
Tit11, B
 x1 | Tit12, S
Tit12, W
Tit12, B
 x1 |
| Tit13
 x2 | Tit14, S
Tit14, W
Tit14, B
 x1 | Tit15, S
Tit15, W
Tit15, B
 x1 | Tit16, S
Tit16, B
 x1 |
| Tit17 Proz
Tit17 Relj
 x1 | Tit18, S
Tit18, W
Tit18, B
 x3 | | |
| Tit19
3x 3x 3x 2x
 3,5 x 13
 4,5 x 60
 Ø 8mm
 3,5 x 38 | | | |









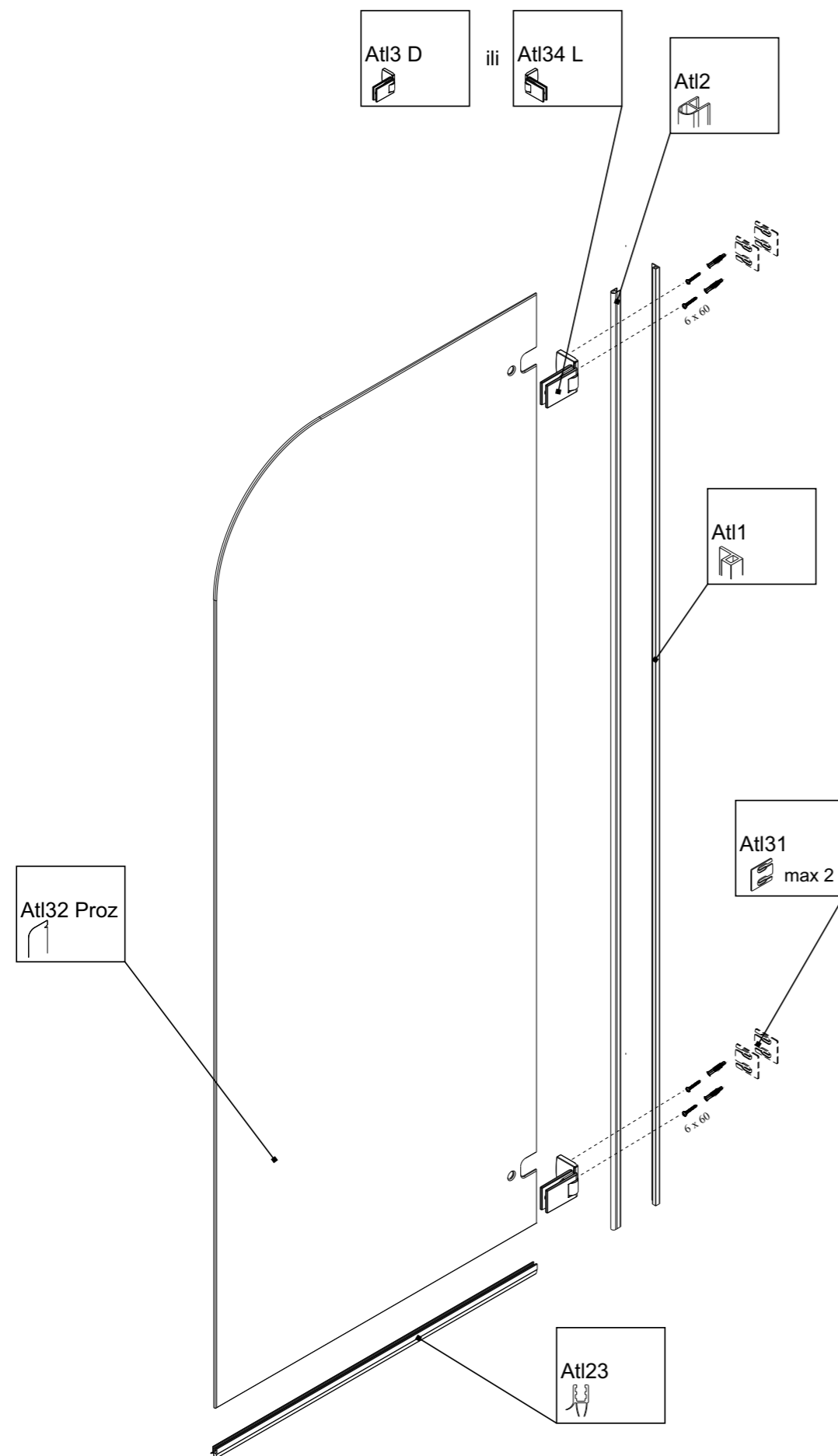









- | | | | |
|---|---|---|--|
| <p>Tit1, S
Tit1, B</p>  <p>x1</p> | <p>Tit2, S
Tit2, B</p>  <p>x1</p> | <p>Tit3</p>  <p>x1</p> | <p>Tit4, S
Tit4, B</p>  <p>x1</p> |
| <p>Tit5, S
Tit5, B</p>  <p>x2</p> | <p>Tit6, S
Tit6, B</p>  <p>x2</p> | <p>Tit7</p>  <p>x2</p> | <p>Tit16, S
Tit16, B</p>  <p>x1</p> |
| <p>Tit18, S
Tit18, B</p>  <p>x3</p> | <p>Tit20 Proz
Tit20 Sivo</p>  <p>x1</p> | <p>Tit21, S
Tit21, B</p>  <p>x1</p> | |
| <p>Tit19</p> <p>3x 3x 3x 2x</p>  <p>3,5 x 13 4,5 x 60 Ø 8mm 3,5 x 35</p> | | | |









TITAN	Specif. br.	Šifra	Opis
	Tit3	3112012	PVC profil ART.375, L=1390 mm, za Titan
	Tit5, S	3113355	Eco lift sistem, fiksna plastika, siva
	Tit5, W	3113353	Eco lift sistem, fiksna plastika, bijela
	Tit5, B	3113351	Eco lift sistem, fiksna plastika, crna
	Tit6, S	3113356	Eco lift sistem, okretna plastika, siva
	Tit6, W	3113354	Eco lift sistem, okretna plastika, bijela
	Tit6, B	3113352	Eco lift sistem, okretna plastika, crna
	Tit7	3113186	Metalna kuglica fi 6 mm
	Tit9, S Tit9, W Tit16, S Tit16, W	3112016	PVC profil E-504 V6, L=2000 mm azur, za st. 6 mm - TITAN
	Tit9, B Tit16, B	3112095	PVC profil G 026 V6, L=2000 mm, crni, pera 12 mm
	Tit12, S	3113188	Gornja spojna plast, spojni pr, siva - Titan II U
	Tit12, W	3113244	Gornja spojna plast, spojni pr, bijela - Titan II U
	Tit12, B	3113178	Gornja spojna plast, spojni pr, crna - Titan II U
	Tit13	3112029	PVC profil H7 - Titan - spojni profili, L=2000 mm
	Tit14, S	3113187	Donja spojna plast, spojni pr, siva - Titan II U
	Tit14, W	3113243	Donja spojna plast, spojni pr, bijela - Titan II U
	Tit14, B	3113177	Donja spojna plast, spojni pr, crna - Titan II U
	Tit15, S	3113189	Brtvena guma, spojni pr, siva - Titan II U
	Tit15, W	3113181	Brtvena guma, spojni pr, bijela - Titan II U
	Tit15, B	3113179	Brtvena guma, spojni pr, crna - Titan II U
	Tit18, S	3113130	Ukrasna kapica s podloškom, siva
	Tit18, W	3113129	Ukrasna kapica s podloškom, bijela
	Tit18, B	3113131	Ukrasna kapica s podloškom, crna
	Tit21, S	6100100	Nosač ručnika L=40 cm, za paravan, silver
	Tit21, B	6100036	Nosač ručnika L=40 cm, za paravan, crna mat









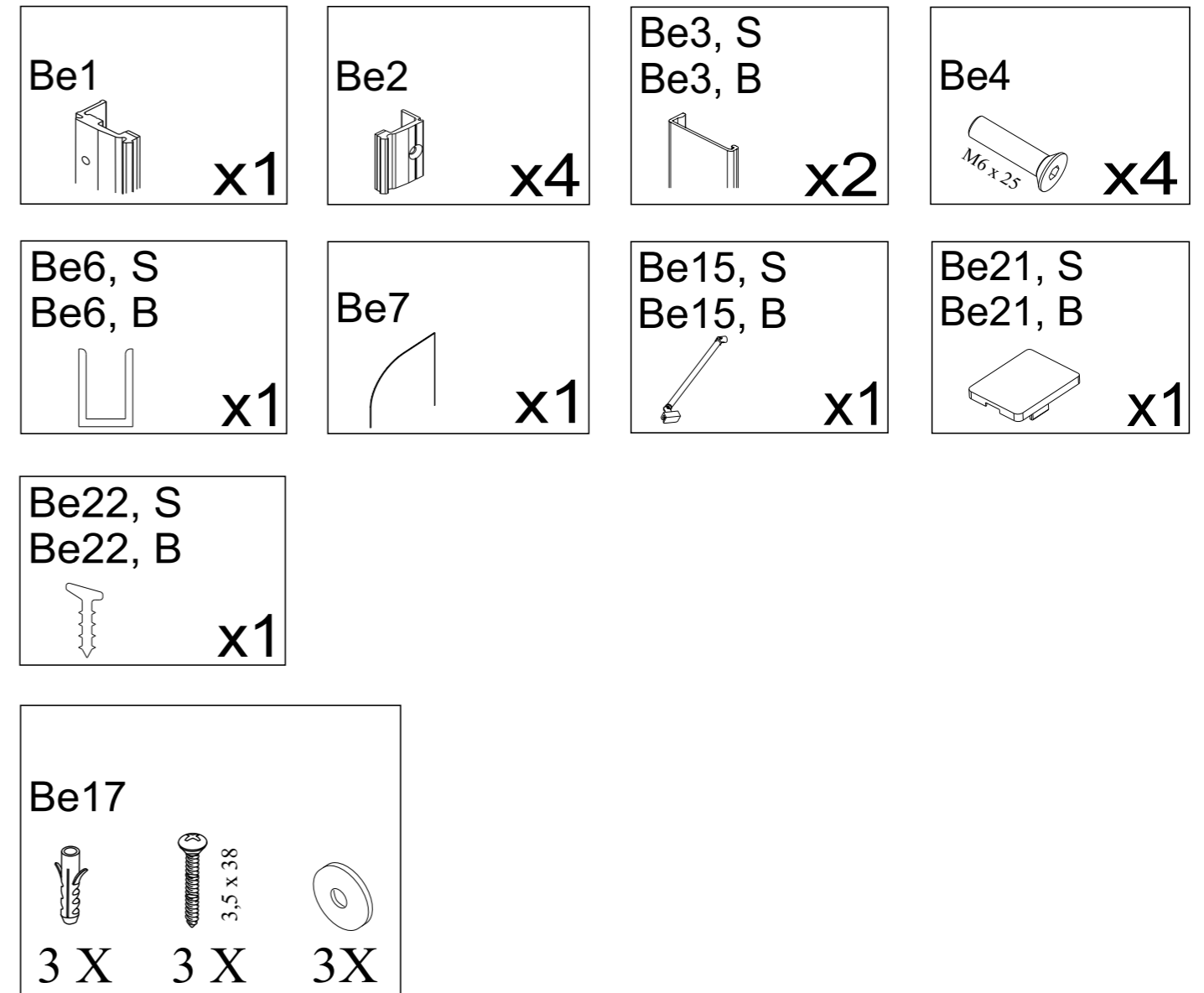
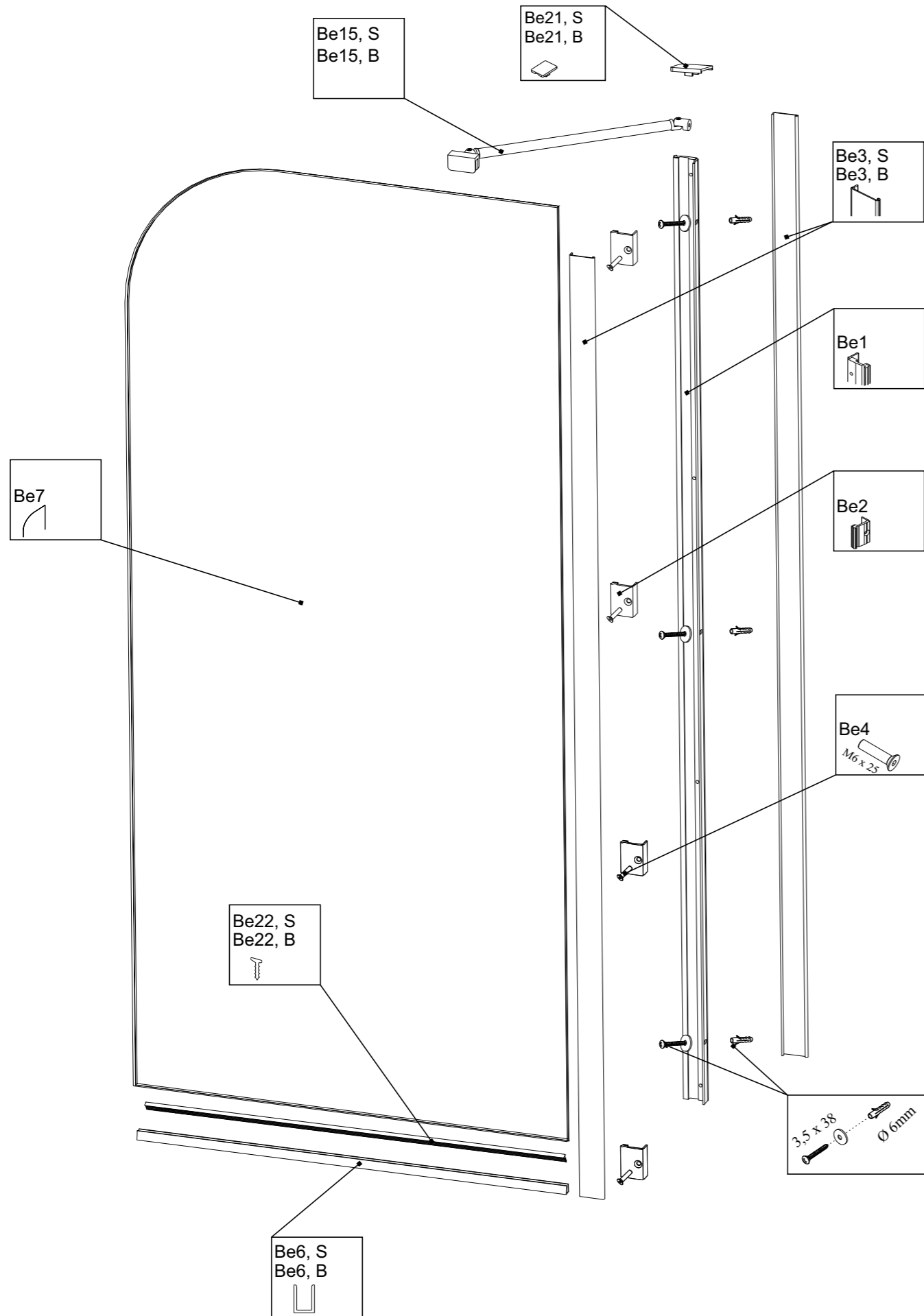

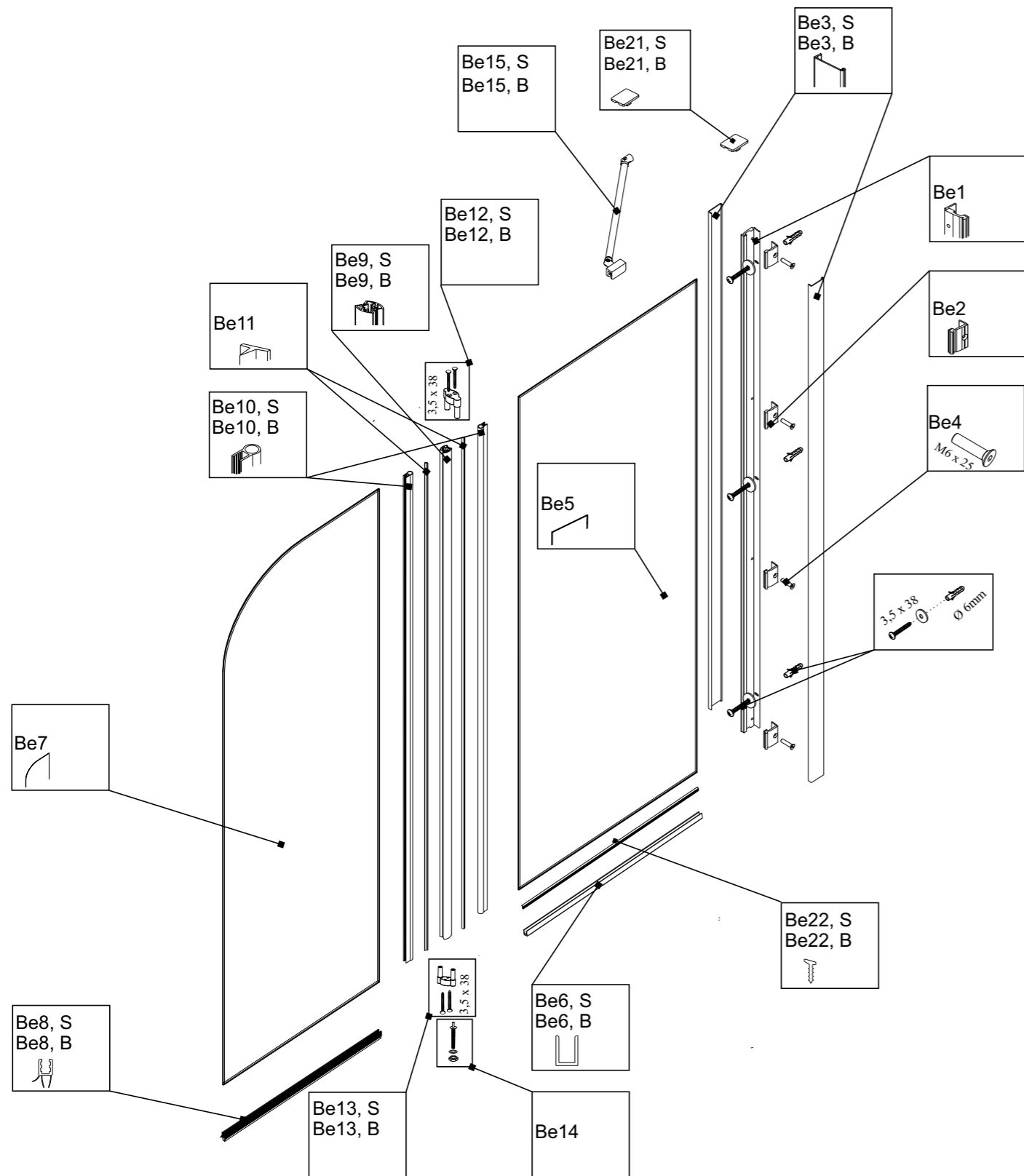

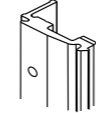
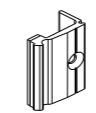
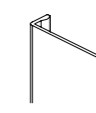
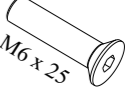

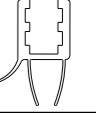

- | | | | |
|--------------------------|------------------|---------------|-------------|
| AtI1
x1 | AtI2
x1 | AtI3 D
x2 | AtI23
x1 |
| AtI31
x2 | AtI32 Proz
x1 | AtI34 L
x2 | |
| AtI28
4x
4x 6 x 60 | | | |

ATLANTIS	Specif. br.	Šifra	Opis
	Atl1	3113082	Zidni brtveni profil Atlantis, L=2200 mm, krom
	Atl2	3112074	PVC profil G 058 V8, L=2200 mm transp
	Atl3 D	3113078	Pant zid-staklo, lift sistem, krom, desni
	Atl34 L	3113077	Pant zid-staklo, lift sistem, krom, lijevi
	Atl5	3113095	Ručka za tuš kabinu Atlantis, kvadratna, krom
	Atl6	3112044	PVC profil mag. M 112 V6 L=2200 mm transp. sivi mag
	Atl7	3112020	PVC profil mag. M 20, V6, L=2200 mm, tr. sivi mag.
	Atl10	3113130	Ukrasna kapica s podloškom, siva
	Atl11	3112016	PVC profil E-504 V6, L=2000 mm azur, za st. 6 mm -TITAN
	Atl12	6100025	Podni brtveni Alu. profil L=1000 mm, silver
	Atl13	3113016	Spojna plastika br. profil, Sigma, kutni
	Atl15 L	3113301	PVC profi mag M 123 L, V8 L=2200 mm, transparent
	Atl35 D	3113300	PVC profi mag M 123 D, V8 L=2200 mm, transparent
	Atl17	3113283	Atlantis donji fiksator, 31x25 mm, inox
	Atl18	3113281	Šipka za fiksiranje 45°, L=500 mm, krom
	Atl19	3113081	Fiksator kutni zid-staklo, krom
	Atl21 L	6100123	Podni brtveni Alu. profil Atlantis L, L=1000 mm, silver
	Atl37 D	6100124	Podni brtveni Alu. profil Atlantis D, L=1000 mm, silver
	Atl23	3112045	PVC profil G 026 V6, L=2400 mm transp, pera 10 mm
	Atl25	6100025	Podni brtveni Alu. profil L=27 mm, silver





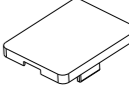



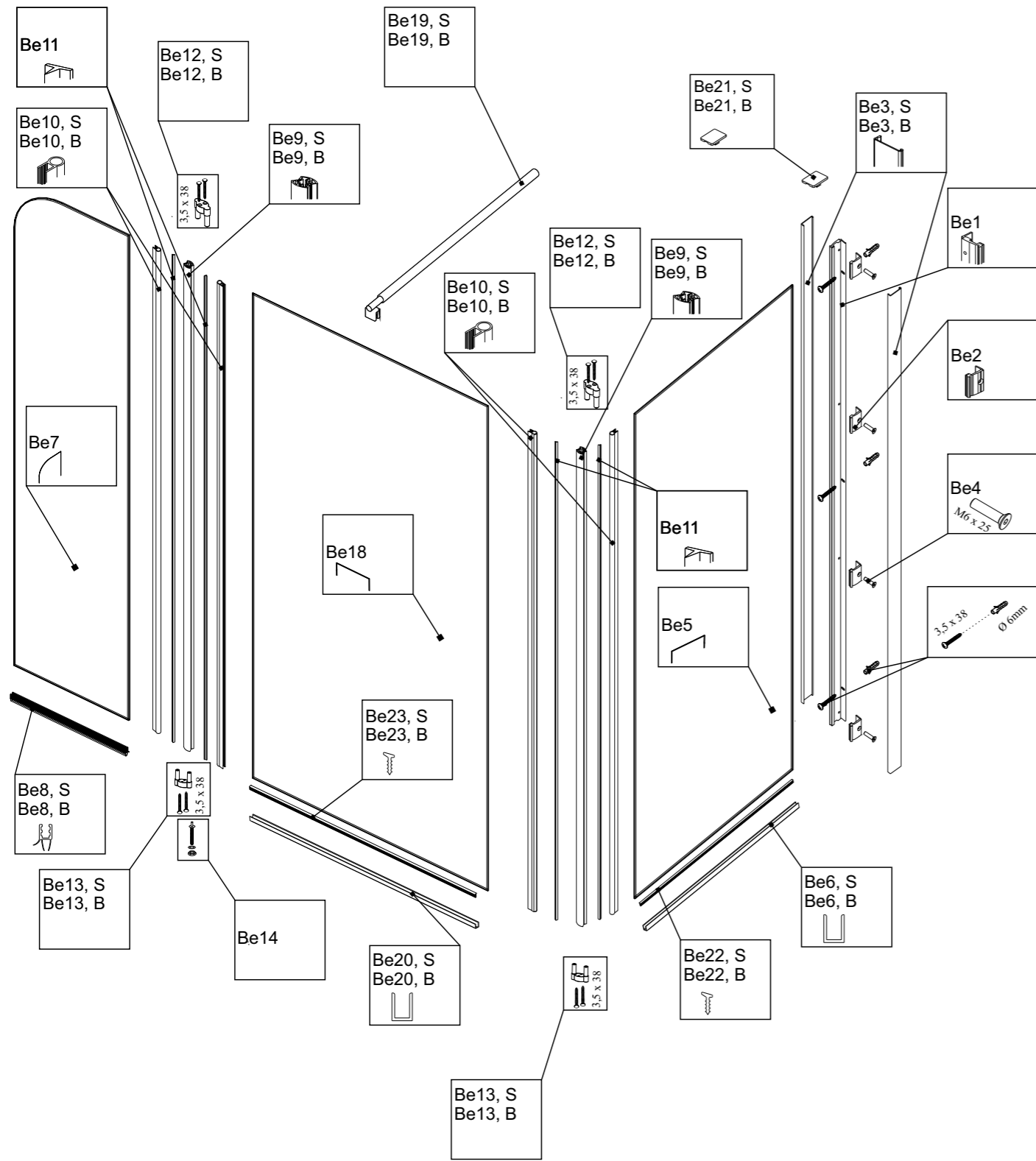

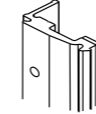
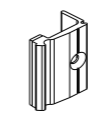
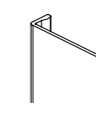
ATLANTIS	Specif. br.	Šifra	Opis
	Atl27	3113280	Šipka za fiksiranje 90°, L=1000 mm, krom
	Atl29 D	3113080	Pant staklo-staklo, lift sistem, krom, desni
	Atl36 L	3113079	Pant staklo-staklo, lift sistem, krom, lijevi
	Atl30	3113279	Šipka za fiksiranje T-spoj, L=1200 mm, krom
		3113278	Šipka za fiksiranje T-spoj, L=1600 mm, krom
		3113284	Šipka za fiksiranje T-spoj, L=2000 mm, krom
	Atl31	3113083	Podložna pločica za pant zid-staklo, transparent
	Atl33	3112021	PVC profil mag. M 20, V8, L=2200 mm, tr. sivi mag.

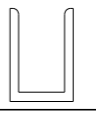

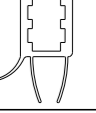
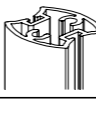

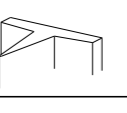
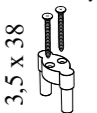
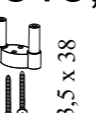

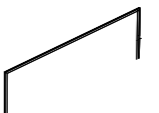
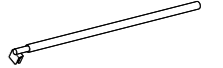
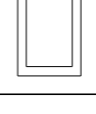
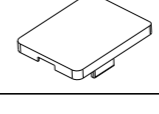
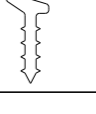
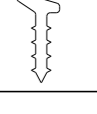





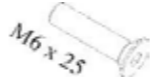

<p>Be1</p>  <p>x1</p>	<p>Be2</p>  <p>x4</p>	<p>Be3, S Be3, B</p>  <p>x2</p>	<p>Be4</p>  <p>x4</p>
<p>Be5</p>  <p>x1</p>	<p>Be6, S Be6, B</p>  <p>x1</p>	<p>Be7</p>  <p>x1</p>	<p>Be8, S Be8, B</p>  <p>x1</p>
<p>Be9, S Be9, B</p>  <p>x1</p>	<p>Be10, S Be10, B</p>  <p>x2</p>	<p>Be11</p>  <p>x2</p>	<p>Be12, S Be12, B</p>  <p>x1</p>
<p>Be13, S Be13, B</p>  <p>x1</p>	<p>Be14</p>  <p>x1</p>	<p>Be15, S Be15, B</p>  <p>x1</p>	<p>Be21, S Be21, B</p>  <p>x1</p>
<p>Be22, S Be22, B</p>  <p>x1</p>			
<p>Be16</p>  <p>3 X 3 X 3X</p>			









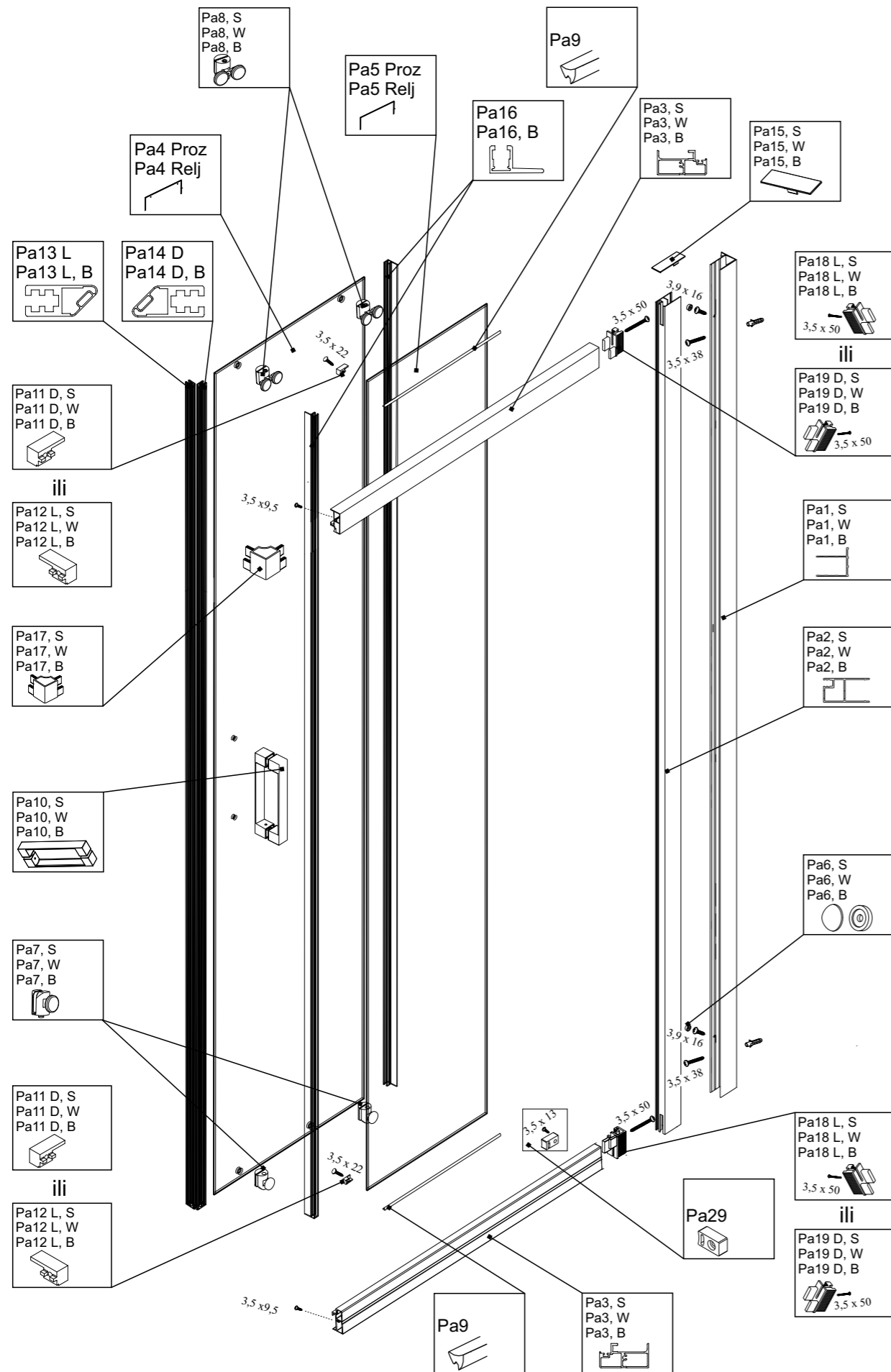

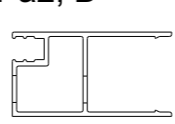
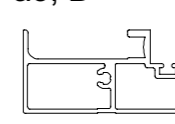
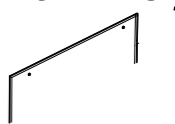

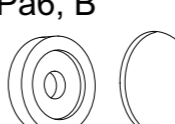
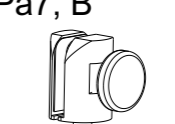

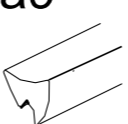
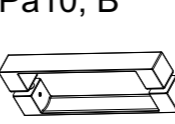
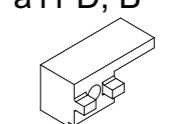
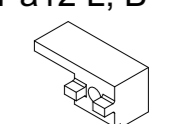
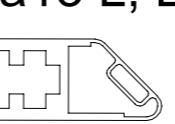
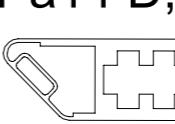
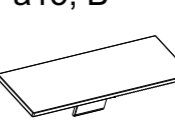
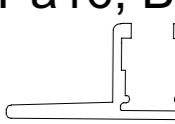
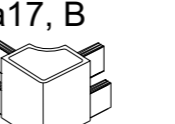
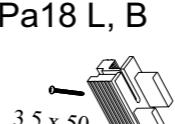
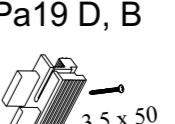
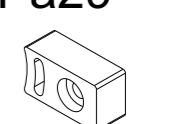
<p>Be1</p>  <p>x1</p>	<p>Be2</p>  <p>x4</p>	<p>Be3, S Be3, B</p>  <p>x2</p>	<p>Be4</p>  <p>M6 x 25 x4</p>
<p>Be5</p>  <p>x1</p>	<p>Be6, S Be6, B</p>  <p>x1</p>	<p>Be7</p>  <p>x1</p>	<p>Be8, S Be8, B</p>  <p>x1</p>
<p>Be9, S Be9, B</p>  <p>x2</p>	<p>Be10, S Be10, B</p>  <p>x4</p>	<p>Be11</p>  <p>x4</p>	<p>Be12, S Be12, B</p>  <p>3,5 x 38 x2</p>
<p>Be13, S Be13, B</p>  <p>3,5 x 38 x2</p>	<p>Be14</p>  <p>x1</p>	<p>Be18</p>  <p>x1</p>	<p>Be19, S Be19, B</p>  <p>x1</p>
<p>Be20, S Be20, B</p>  <p>x1</p>	<p>Be21, S Be21, B</p>  <p>x1</p>	<p>Be22, S Be22, B</p>  <p>x1</p>	<p>Be23, S Be23, B</p>  <p>x1</p>
<p>Be16</p>  <p>3 X 3 X 3 X</p>			









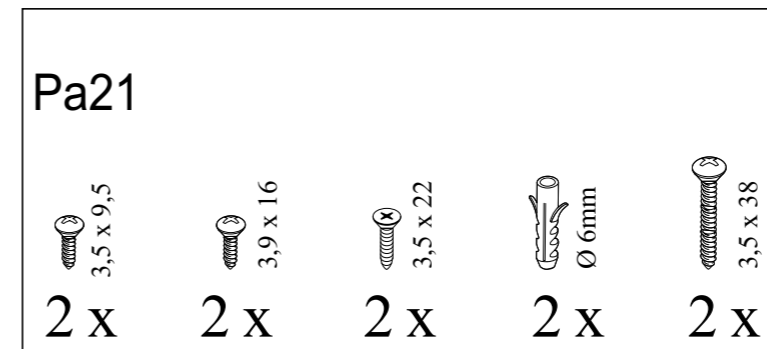
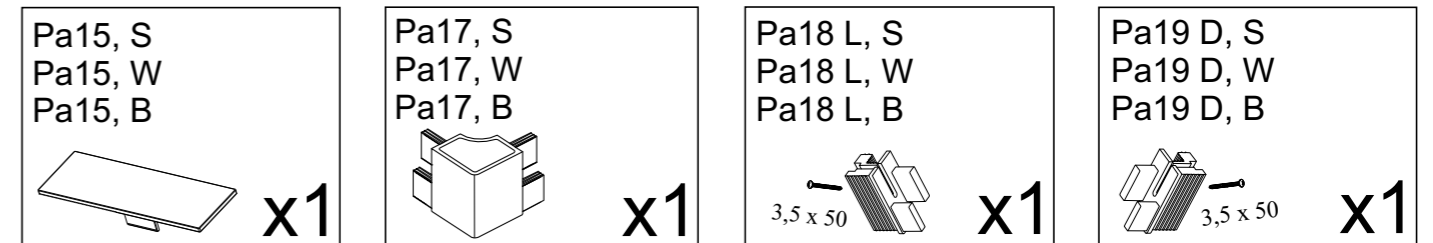
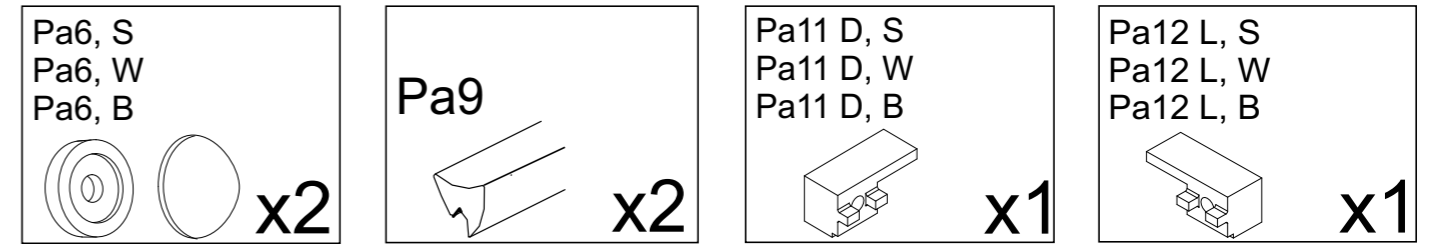
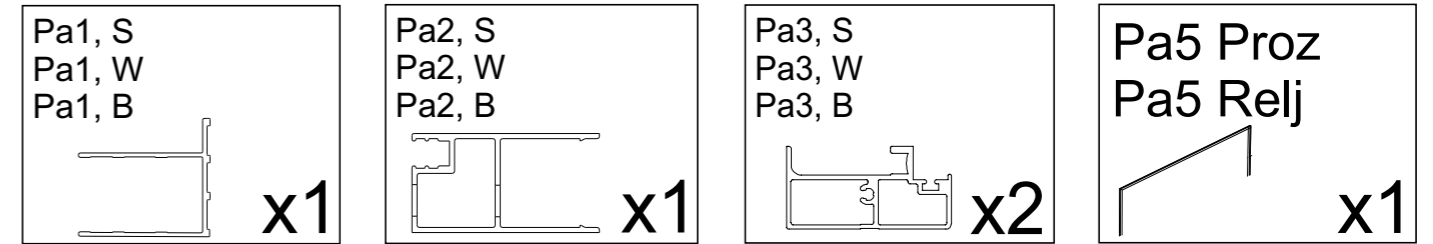
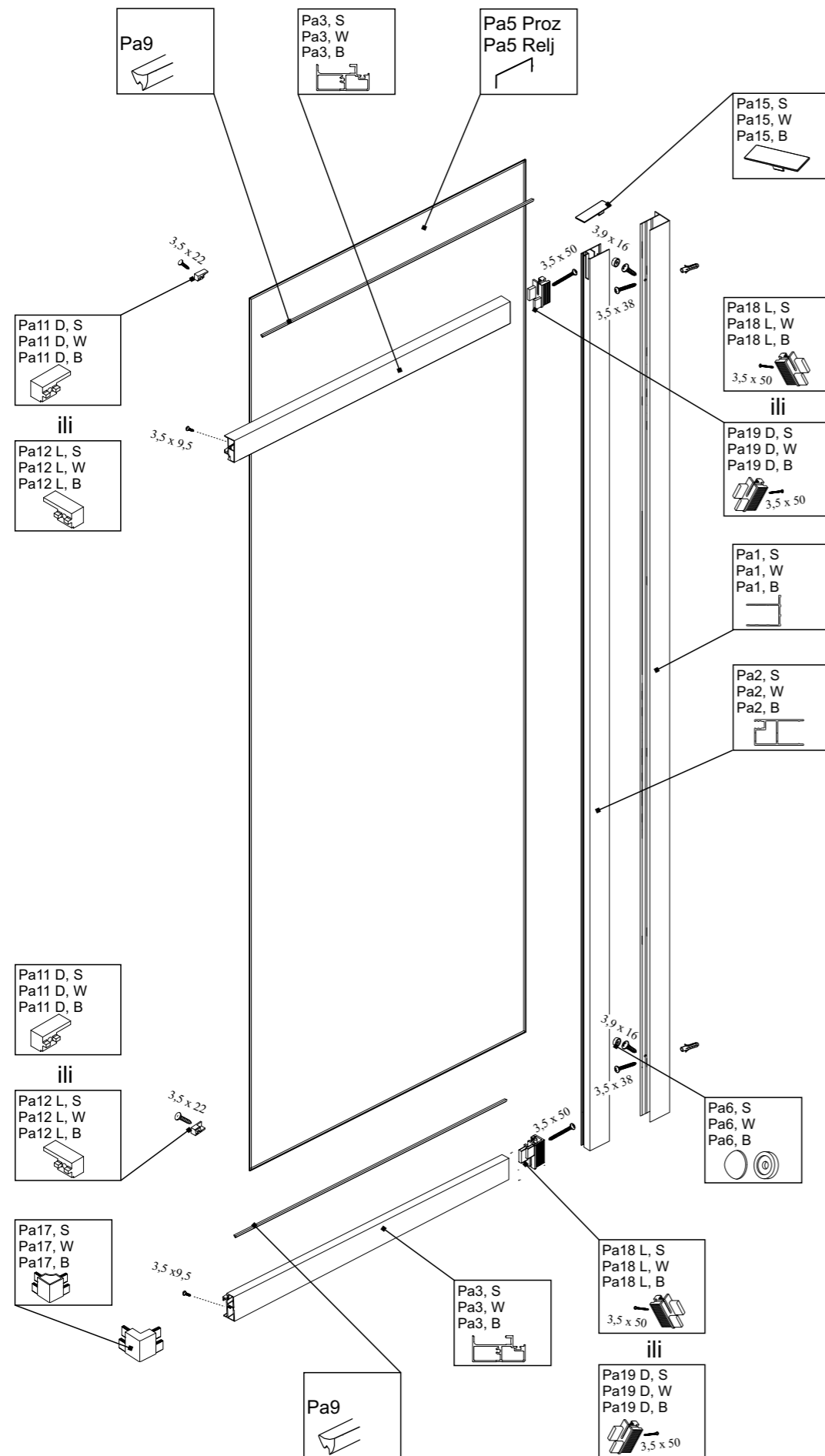

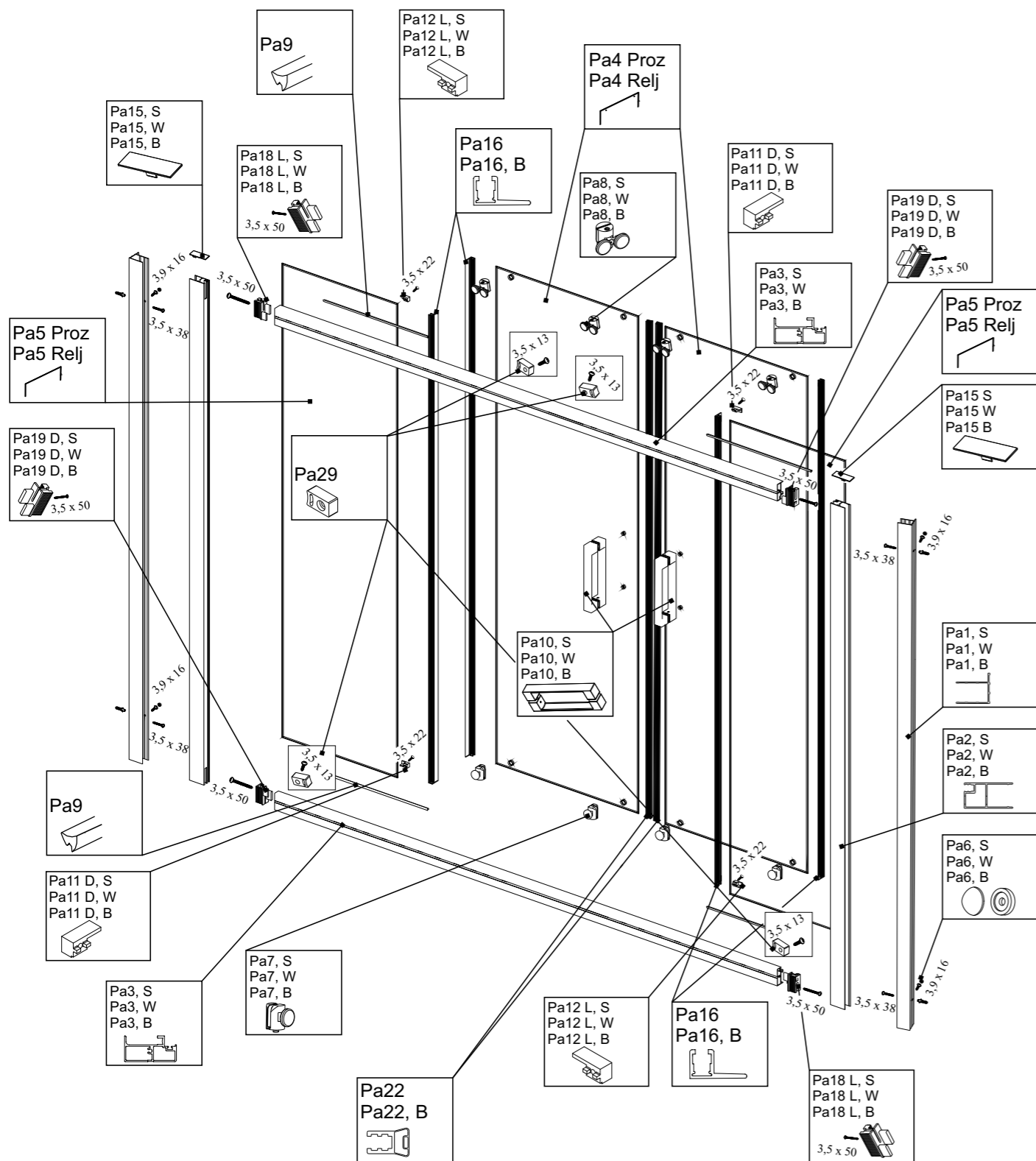
BETA	Specif. br.	Šifra	Opis
	Be4	3113203	Vijak M6x25 DIN 7991 rostfrei A2
	Be6,S Be20,S	6100035	Alu. profil U 15x11x15, L=1000 mm, silver
	Be6,B Be20,B	6100062	Alu. profil U 15x11x15, L=1000 mm, crna mat
	Be8, S	3112045	PVC profil G 026 V6, L=2400 mm transp, pera 10 mm
	Be8, B	3112095	PVC profil G 026 V6, L=360 mm, crna, pera 12 mm
	Be11	3112029	PVC profil H7 - Titan - spojni profili, L=2000 mm
	Be12, S	3113188	Gornja spojna plast, spojni pr, siva - Titan II U
	Be12, B	3113178	Gornja spojna plast, spojni pr, crna - Titan II U
	Be13, S	3113187	Donja spojna plast, spojni pr, siva - Titan II U
	Be13, B	3113177	Donja spojna plast, spojni pr, crna - Titan II U
	Be14	3113147	Navojna šipka M6x50, inox
	Be15, S	3113029	Metalna šipka za kutno fiksiranje, 40 cm, chrom
	Be15, B	6100038	Metalna šipka za kutno fiksiranje, 40 cm, crna mat
	Be19, S	3111083	Šipka za fiksiranje stijene, chrom
	Be19, B	3111086	Šipka za fiksiranje stijene, crna mat
	Be21, S	3113209	Poklopac za zidni profil Eris - chrom
	Be21, B	3113265	Poklopac za zidni profil Eris - crni
	Be22, S Be23, S	3112024	PVC profil F60/2 vertikalni za profil E-8854,prozi, L=1000 mm
	Be22, B Be23, B	3112024C	PVC profil F60/2 vertikalni za profil E-8854,crna, L=1000 mm

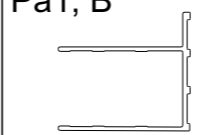
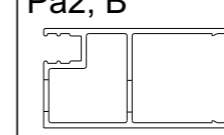
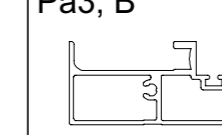

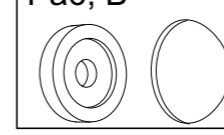
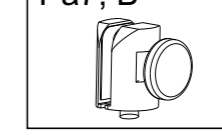
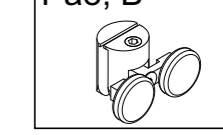
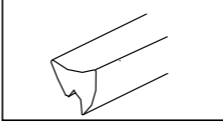
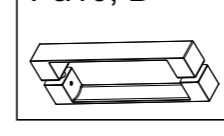
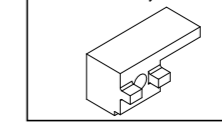
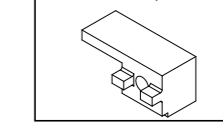
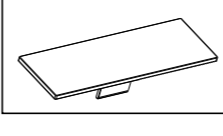
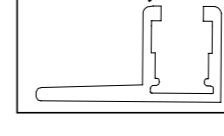
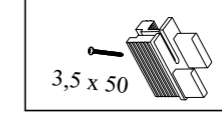
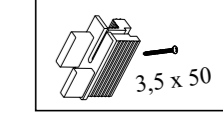
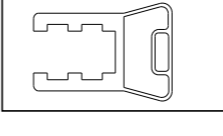
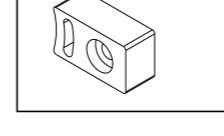
Pa1, S Pa1, W Pa1, B  x1	Pa2, S Pa2, W Pa2, B  x1	Pa3, S Pa3, W Pa3, B  x2	Pa4 Proz Pa4 Relj  x1
Pa5 Proz Pa5 Relj  x1	Pa6, S Pa6, W Pa6, B  x2	Pa7, S Pa7, W Pa7, B  x2	Pa8, S Pa8, W Pa8, B  x2
Pa9  x2	Pa10, S Pa10, W Pa10, B  x1	Pa11 D, S Pa11 D, W Pa11 D, B  x1	Pa12 L, S Pa12 L, W Pa12 L, B  x1
Pa13 L, Pa13 L, B  x1	Pa14 D Pa14 D, B  x1	Pa15, S Pa15, W Pa15, B  x1	Pa16 Pa16, B  x2
Pa17, S Pa17, W Pa17, B  x1	Pa18 L, S Pa18 L, W Pa18 L, B  x1	Pa19 D, S Pa19 D, W Pa19 D, B  x1	Pa29  x1
Pa20  3,5 x 9,5  3,5 x 13  3,9 x 16  3,5 x 22  Ø 6mm  3,5 x 38  4 mm 2 x 1 x 2 x 2 x 2 x 2 x 1 x			







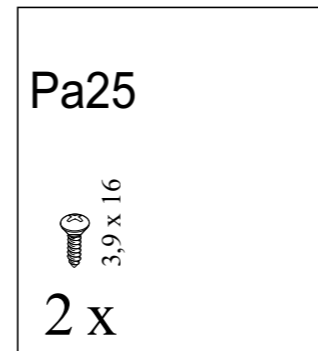
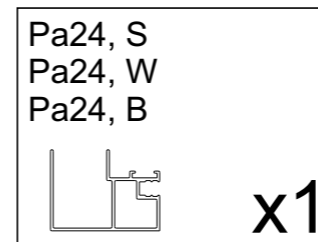
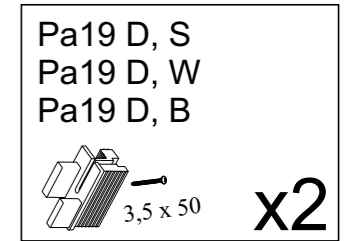
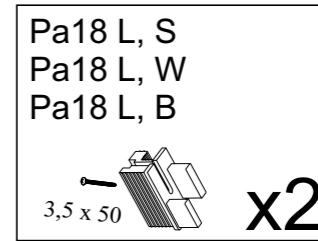
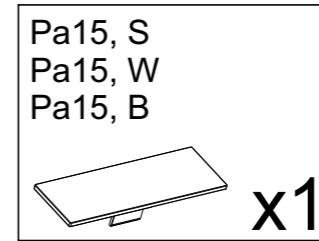
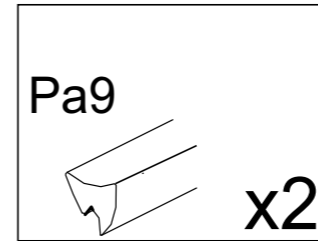
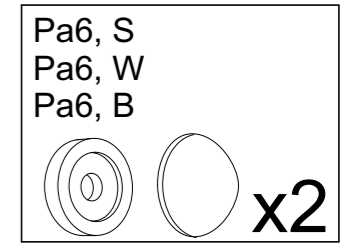
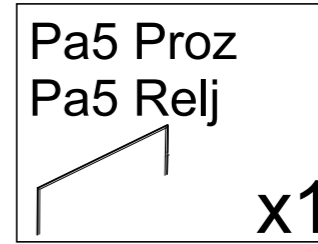
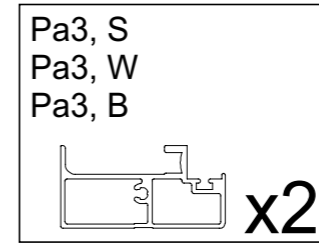
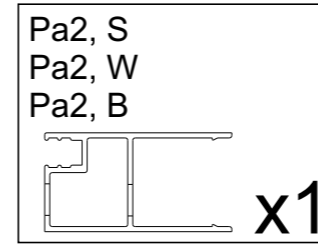
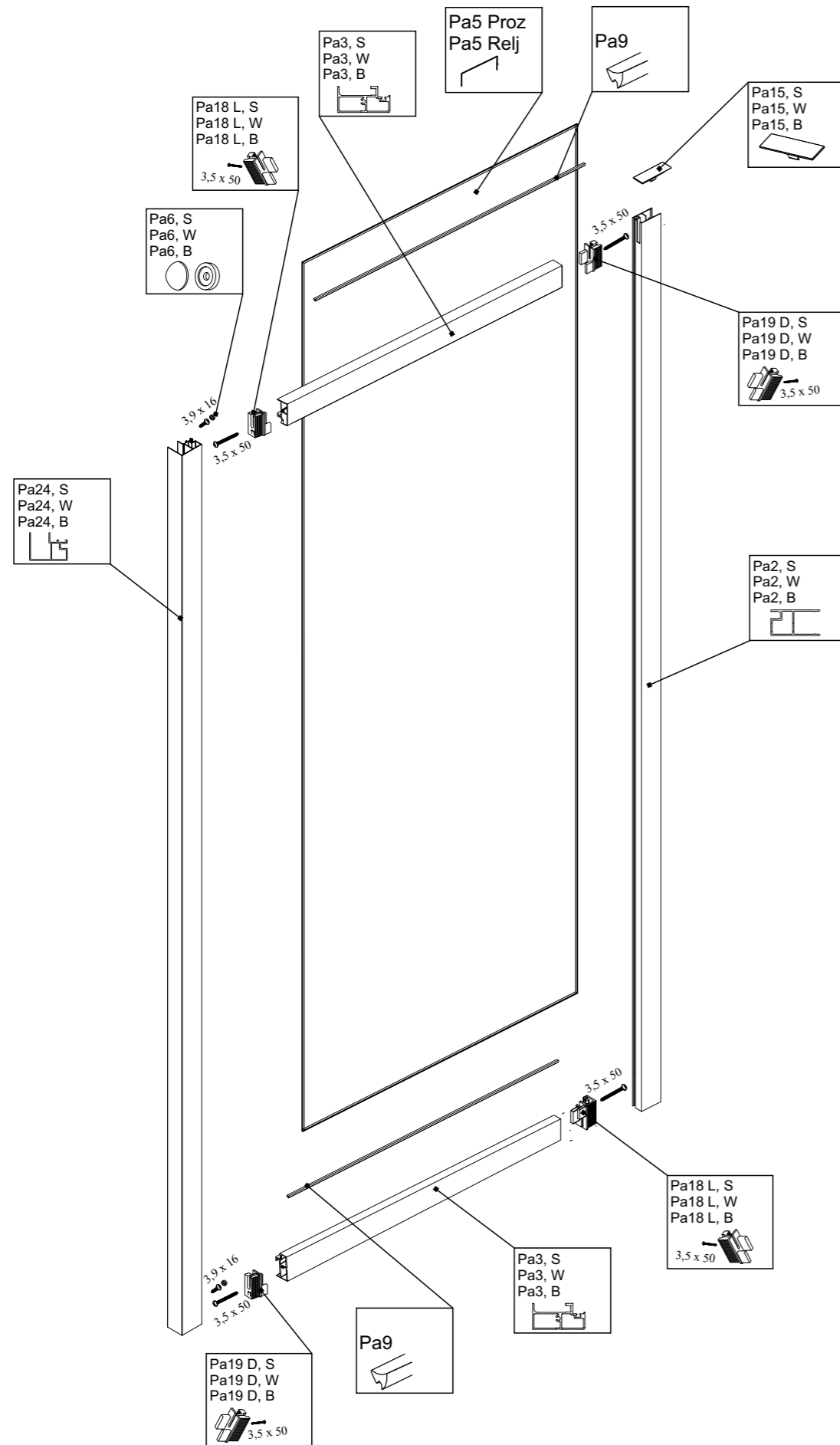

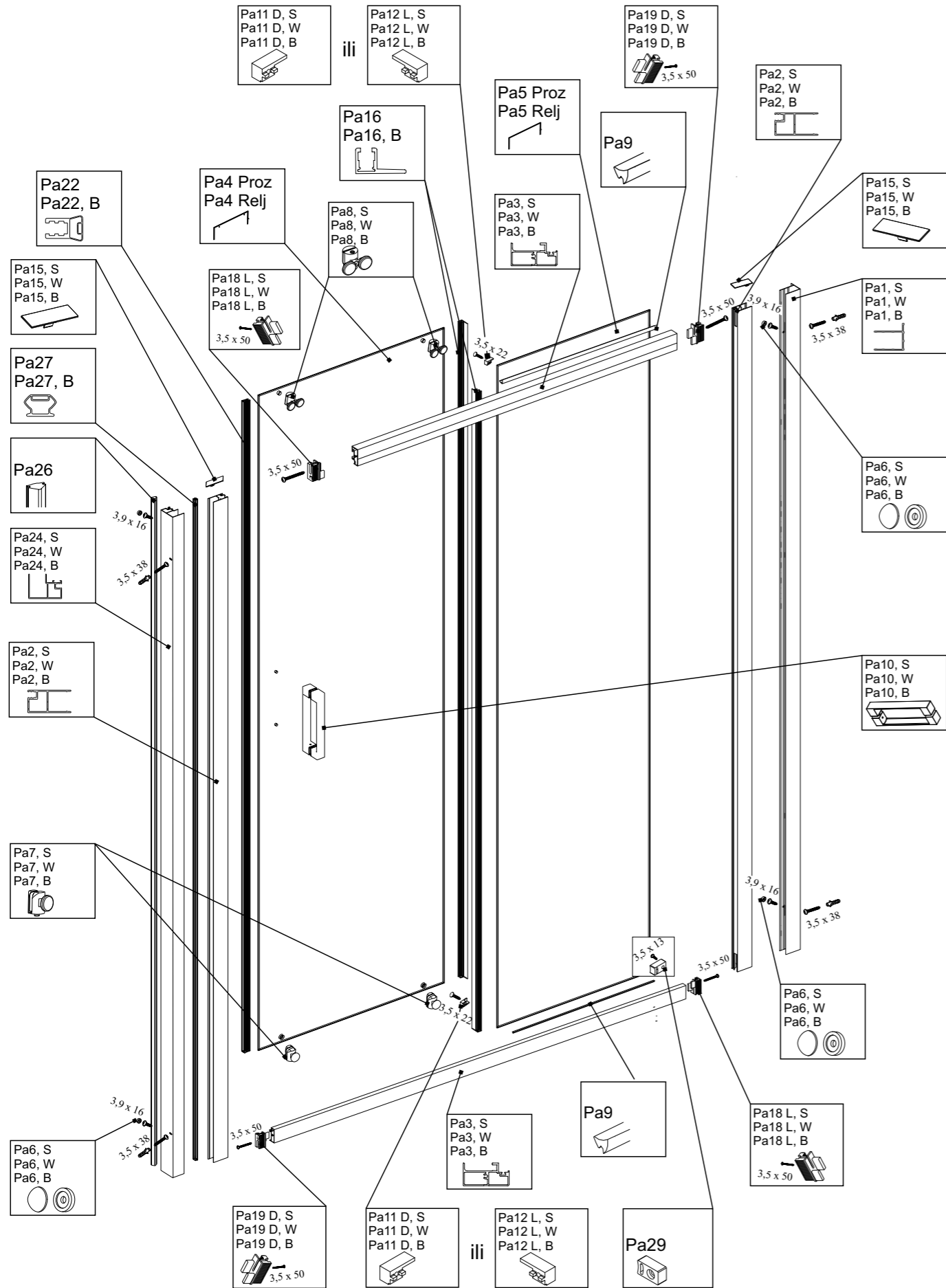

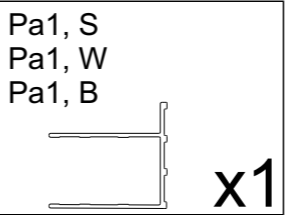
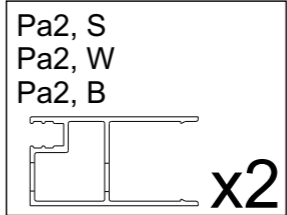
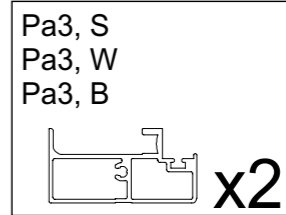
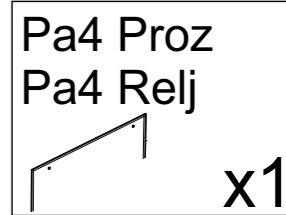
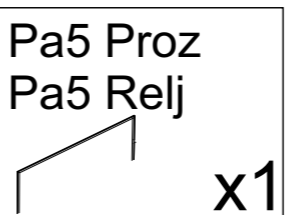
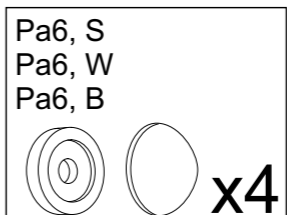
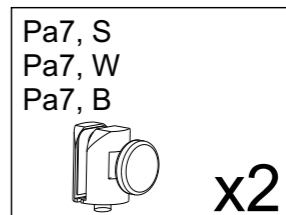
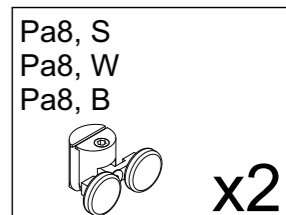
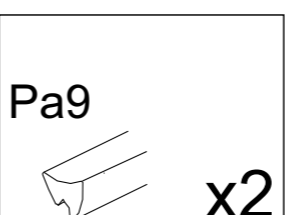
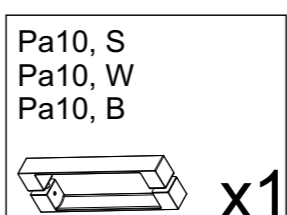
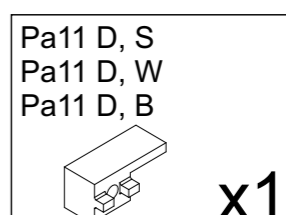
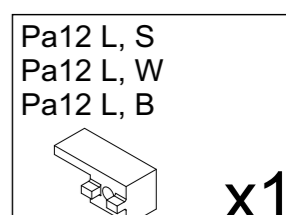
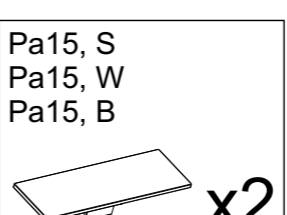
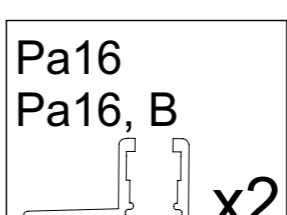
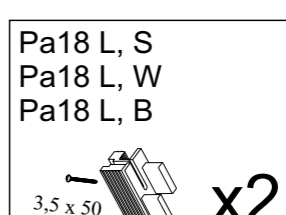
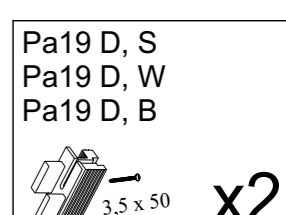
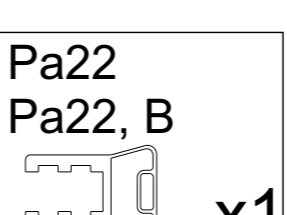
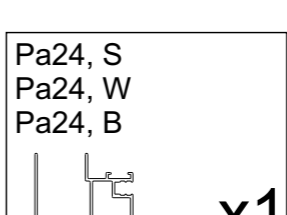
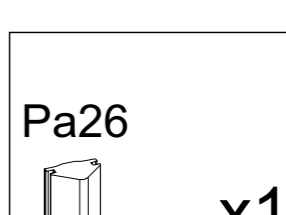
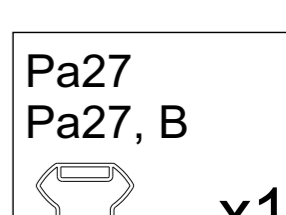













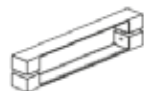

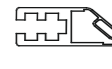
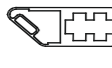

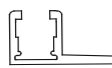

- | | | | |
|---|---|--|--|
| <p>Pa1, S
Pa1, W
Pa1, B</p>  <p>x2</p> | <p>Pa2, S
Pa2, W
Pa2, B</p>  <p>x2</p> | <p>Pa3, S
Pa3, W
Pa3, B</p>  <p>x2</p> | <p>Pa4 Proz
Pa4 Relj</p>  <p>x2</p> |
| <p>Pa5 Proz
Pa5 Relj</p>  <p>x2</p> | <p>Pa6, S
Pa6, W
Pa6, B</p>  <p>x8</p> | <p>Pa7, S
Pa7, W
Pa7, B</p>  <p>x4</p> | <p>Pa8, S
Pa8, W
Pa8, B</p>  <p>x4</p> |
| <p>Pa9</p>  <p>x4</p> | <p>Pa10, S
Pa10, W
Pa10, B</p>  <p>x2</p> | <p>Pa11 D, S
Pa11 D, W
Pa11 D, B</p>  <p>x2</p> | <p>Pa12 L, S
Pa12 L, W
Pa12 L, B</p>  <p>x2</p> |
| <p>Pa15, S
Pa15, W
Pa15, B</p>  <p>x2</p> | <p>Pa16
Pa16, B</p>  <p>x4</p> | <p>Pa18 L, S
Pa18 L, W
Pa18 L, B</p>  <p>x2</p> | <p>Pa19 D, S
Pa19 D, W
Pa19 D, B</p>  <p>x2</p> |
| <p>Pa22
Pa22, B</p>  <p>x2</p> | <p>Pa29</p>  <p>x4</p> | | |
| <p>Pa23</p>  <p>8 x</p>  <p>4 x</p>  <p>4 x</p>  <p>4 x</p>  <p>4 x</p>  <p>1 x</p> | | | |

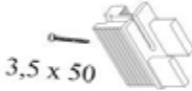
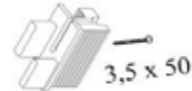



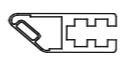



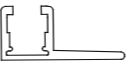

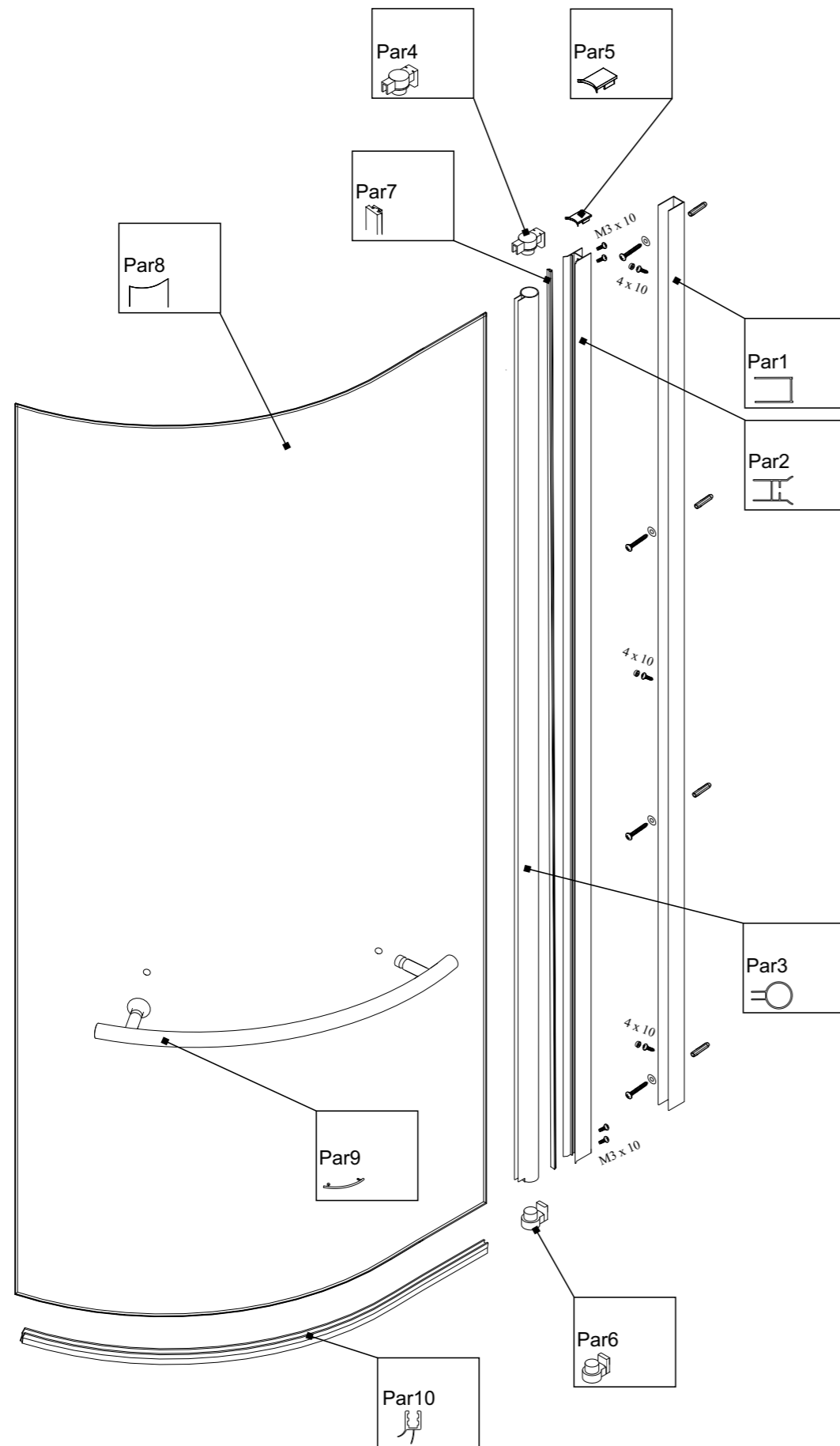

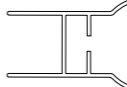
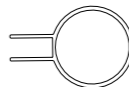
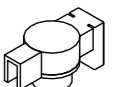

- | | | | |
|--|---|--|--|
| Pa1, S
Pa1, W
Pa1, B
 x1 | Pa2, S
Pa2, W
Pa2, B
 x2 | Pa3, S
Pa3, W
Pa3, B
 x2 | Pa4 Proz
Pa4 Relj
 x1 |
| Pa5 Proz
Pa5 Relj
 x1 | Pa6, S
Pa6, W
Pa6, B
 x4 | Pa7, S
Pa7, W
Pa7, B
 x2 | Pa8, S
Pa8, W
Pa8, B
 x2 |
| Pa9
 x2 | Pa10, S
Pa10, W
Pa10, B
 x1 | Pa11 D, S
Pa11 D, W
Pa11 D, B
 x1 | Pa12 L, S
Pa12 L, W
Pa12 L, B
 x1 |
| Pa15, S
Pa15, W
Pa15, B
 x2 | Pa16
Pa16, B
 x2 | Pa18 L, S
Pa18 L, W
Pa18 L, B
 x2 | Pa19 D, S
Pa19 D, W
Pa19 D, B
 x2 |
| Pa22
Pa22, B
 x1 | Pa24, S
Pa24, W
Pa24, B
 x1 | Pa26
 x1 | Pa27
Pa27, B
 x1 |
| Pa29
 x1 | | | |
| Pa28
 3,9 x 16  3,5 x 13  3,5 x 22  Ø 6mm  3,5 x 38  4 mm
4 x 1 x 2 x 4 x 4 x 1 x | | | |

SAVANA / PANDORA	Specif. br.	Šifra	Opis
	Sav6, S Pa6, S	3113130	Ukrasna kapica s podloškom, siva
	Sav6, W Pa6, W	3113129	Ukrasna kapica s podloškom, bijela
	Sav6, B Pa6, B	3113131	Ukrasna kapica s podloškom, crna
	Sav7, S Pa7, S	3113162	Kotačić za Savanu, donji, sivi
	Sav7, W Pa7, W	3113160	Kotačić za Savanu, donji, bijeli
	Sav7, B Pa7, B	3113090	Kotačić za Savanu, donji, crni
	Sav8, S Pa8, S	3113019	Kotačić za Savanu, gornji, sivi - dupli
	Sav8, W Pa8, W	3113018	Kotačić za Savanu, gornji, bijeli - dupli
	Sav8, B Pa8, B	3113089	Kotačić za Savanu, gornji, crni - dupli
	Sav9 Pa9	3112004	PVC profil F60 vertikalni za profil TS-4175, proz., L=1000 mm
	Sav10, W Pa10, W	3113055	Ručke za tuš kabinu cod. 1015 - bijela
	Sav10 Pa10	3113054	Ručke za tuš kabinu cod. 1015 - chrom
	Sav10, B Pa10, B	3113096	Ručke za tuš kabinu cod. 1015 - crna mat
	Sav11 D, S Pa11 D, S	3113223	Plastika za učvršćenje fix. stakla - D, chrom
	Sav11 D, W Pa11 D, W	3113218	Plastika za učvršćenje fix. stakla - D, bijela
	Sav11 D, B Pa11 D, B	3113274	Plastika za učvršćenje fix. stakla - D, crna
	Sav12 L, S Pa12 L, S	3113222	Plastika za učvršćenje fix. stakla - L, chrom
	Sav12 L, W Pa12 L, W	3113217	Plastika za učvršćenje fix. stakla - L, bijela
	Sav12 L, B Pa12 L, B	3113273	Plastika za učvršćenje fix. stakla - L, crna
	Sav13 L	3112083	PVC profil mag M 126 L, V6 L=2000 mm, transp.sivi mag
	Sav13 L, B	3112094	PVC profil mag M 126 L, V6 L=2000 mm, crna
	Sav14 D	3112084	PVC profil mag M 126 D, V6 L=2000 mm, transp.sivi mag
	Sav14 D, B	3112093	PVC profil mag M 126 D, V6 L=2000 mm, crna
	Sav15, S Pa15, S	3113205	Poklopac za zid. prof. Savana, Galaxy, Sogno - sivi
	Sav15, W Pa15, W	3113204	Poklopac za zid. prof. Savana, Galaxy, Pandora - bijeli
	Sav15, B Pa15, B	3113270	Poklopac za zidni profil Savana, Pandora - crni
	Sav16	3112015	PVC profil E-503 V6, L=1990mm azurna, za staklo 6 mm
	Sav16, B	3113305	PVC profil G 013 V5-6, L=1985 mm, crna, pero 14 mm
	Pa16	3112015	PVC profil E-503 V6, L=1990mm azurna, za staklo 6 mm
	Pa16, B	3113305	PVC profil G 013 V5-6, L=1985 mm, crna, pero 14 mm
	Sav17, S Pa17, S	3113224	Spojna kutna plastika za profil E-15484, chrom
	Sav17, W Pa17, W	3113219	Spojna kutna plastika za profil E-15484, bijela
	Sav17, B Pa17, B	3113275	Spojna kutna plastika za profil E-15484, crna

SAVANA / PANDORA	Specif. br.	Šifra	Opis
	Sav18 L, S Pa18 L, S	3113220	Spojna plastika luk-vert. profil - L, chrom
	Sav18 L, W Pa18 L, W	3113215	Spojna plastika luk-vert. profil - L, bijela
	Sav18 L, B Pa18 L, B	3113271	Spojna plastika luk-vert. profil - L, crna
	Sav19 D, S Pa19 D, S	3113221	Spojna plastika luk-vert. profil - D, chrom
	Sav19 D, W Pa19 D, W	3113216	Spojna plastika luk-vert. profil - D, bijela
	Sav19 D, B Pa19 D, B	3113272	Spojna plastika luk-vert. profil - D, crna
	Sav22 Pa22	3112014	PVC profil mag. M 112 V6 L=1985 mm, transp. sivi mag
	Sav22, B Pa22, B	3113307	PVC profi mag M 112, V6 L=2000 mm, crni
	Sav26 Pa26	3112073	PVC profil ART.TP145/83, transparent, L=2000 mm
	Sav27 Pa27	3112056	PVC profil mag. 31M, L=2000 mm, siva – Saturno
	Sav27, B Pa27, B	3112008	PVC profil mag. M 032, L=2000 mm, crni 9011
	Sav29 L	3112057	PVC profil mag. M 121 L, V4 L=1990 mm transp. sivi mag
	Sav29 L, B	3113303	PVC profi mag M 121 L, V4 L=1990 mm, crna
	Sav30 D	3112058	PVC profil mag. M 121 D, V4 L=1990 mm transp. sivi mag
	Sav30 D, B	3113304	PVC profi mag M 121 D, V4 L=1990 mm, crni
	Sav32 Pa29	3113091	Stoperi/graničnici za kotačiće, transparent
	Sav33, S	6100200	Kotačić za Savanu poluk., gornji dupli, silver
	Sav33, W	6100199	Kotačić za Savanu poluk., gornji dupli, bijela
	Sav33, B	6100201	Kotačić za Savanu poluk., gornji dupli, crna mat
	Sav34	6100211	PVC profil E-503 V6, L=1985 mm azurna, za staklo 5 mm
	Sav34, B	3113305	PVC profil G 013 V5-6, L=1985 mm, crna, pero 14 mm









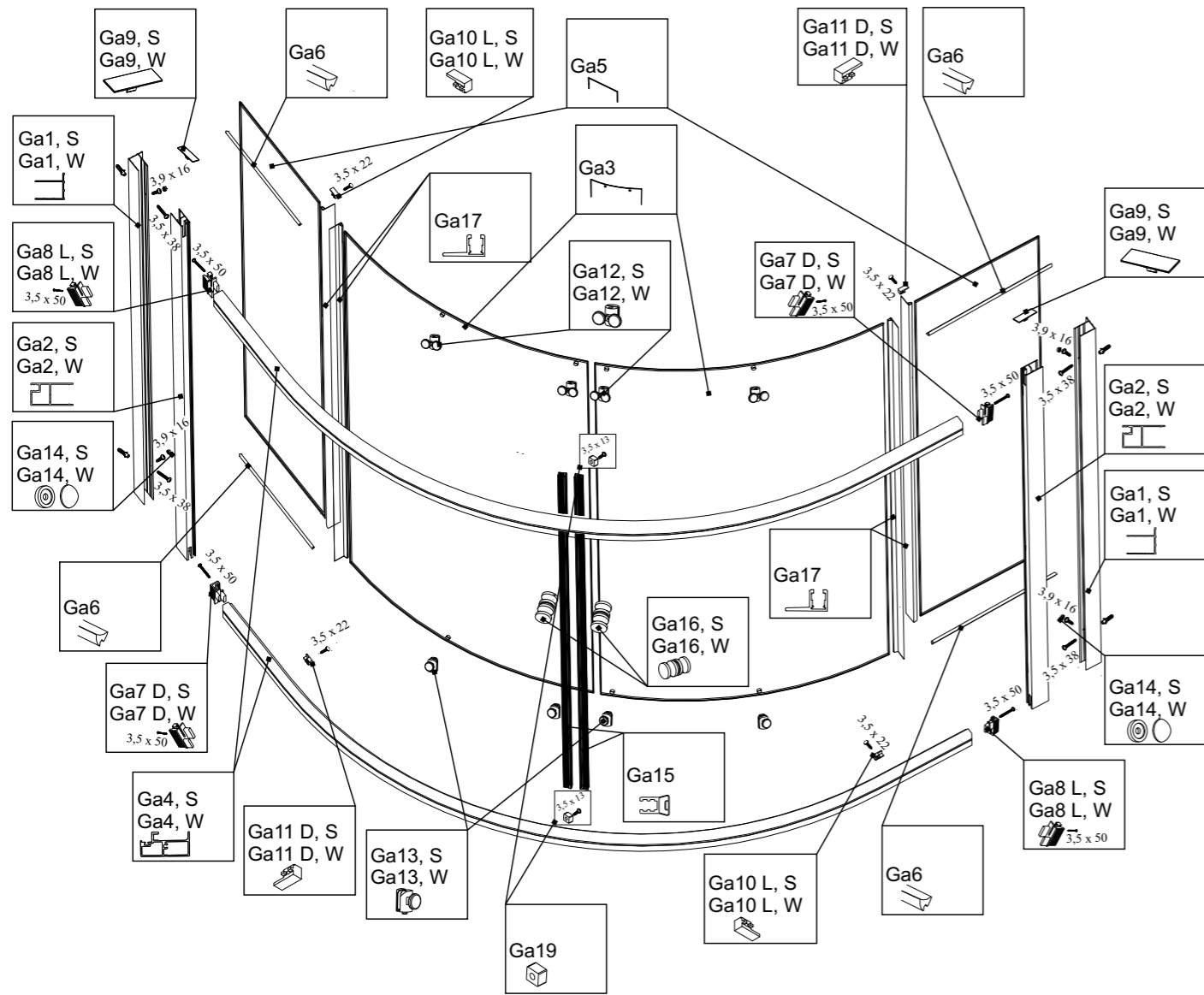

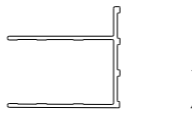
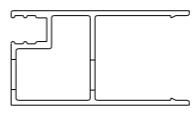
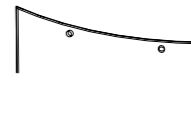
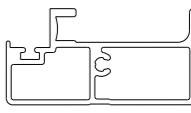

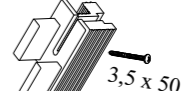
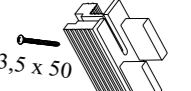

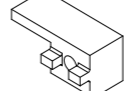
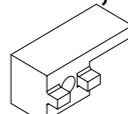
- | | | | |
|--|---|---|---|
| <p>Par1</p>  <p>x1</p> | <p>Par2</p>  <p>x1</p> | <p>Par3</p>  <p>x1</p> | <p>Par4</p>  <p>x1</p> |
| <p>Par5</p>  <p>x1</p> | <p>Par6</p>  <p>x1</p> | <p>Par7</p>  <p>x1</p> | <p>Par8</p>  <p>x1</p> |
| <p>Par9</p>  <p>x1</p> | <p>Par10</p>  <p>x1</p> | | |
| <p>Par11</p>  <p>3 X 3 X 4 X 3 X</p> | | | |

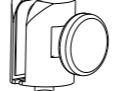

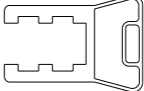

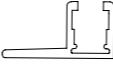







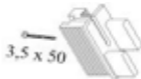

PARMA	Specif. br.	Šifra	Opis
	Par4	7040130	Gornji okretni dio, Parma
	Par5	7040131	Poklopac profila, Parma
	Par6	7040132	Donji okretni dio, Parma
	Par7	7040133	Brtva okretnog profila, Parma
	Par8	7040134	Okretna vrata, Parma
	Par9	7040135	Ručka, Parma
	Par10, L	6100513	Donji PVC profil za paravan Parma L
	Par10, D	6100512	Donji PVC profil za paravan Parma D
	Par11	7040137	Montažni set, Parma









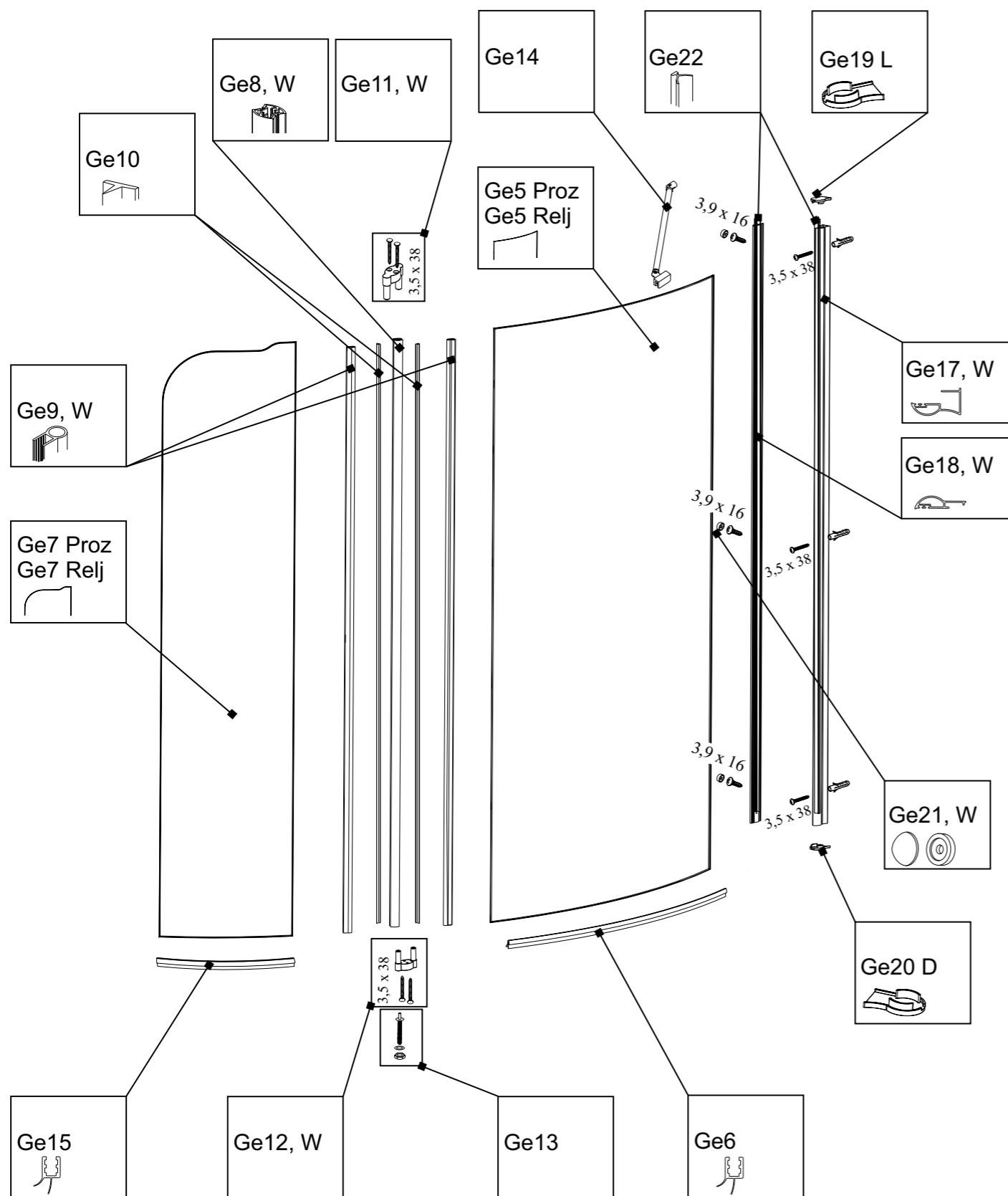

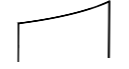

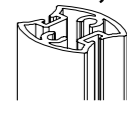

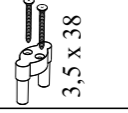
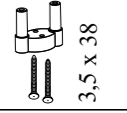



- | | | | |
|--|--|---|--|
| <p>Ga1, S
Ga1, W</p>  <p>x2</p> | <p>Ga2, S
Ga2, W</p>  <p>x2</p> | <p>Ga3</p>  <p>x2</p> | <p>Ga4, S
Ga4, W</p>  <p>x2</p> |
| <p>Ga5</p>  <p>x2</p> | <p>Ga6</p>  <p>x4</p> | <p>Ga7 D, S
Ga7 D, W</p>  <p>x2</p> | <p>Ga8 L, S
Ga8 L, W</p>  <p>x2</p> |
| <p>Ga9, S
Ga9, W</p>  <p>x2</p> | <p>Ga10 L, S
Ga10 L, W</p>  <p>x2</p> | <p>Ga11 D, S
Ga11 D, W</p>  <p>x2</p> | <p>Ga12, S
Ga12, W</p>  <p>x4</p> |
| <p>Ga13, S
Ga13, W</p>  <p>x4</p> | <p>Ga14, S
Ga14, W</p>  <p>x8</p> | <p>Ga15</p>  <p>x2</p> | <p>Ga16, S
Ga16, W</p>  <p>x2</p> |
| <p>Ga17</p>  <p>x4</p> | <p>Ga19</p>  <p>x2</p> | <p>Ga18</p>  <p>4 x 2 x 4 x 4 x 4 x 1 x</p> | |



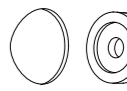





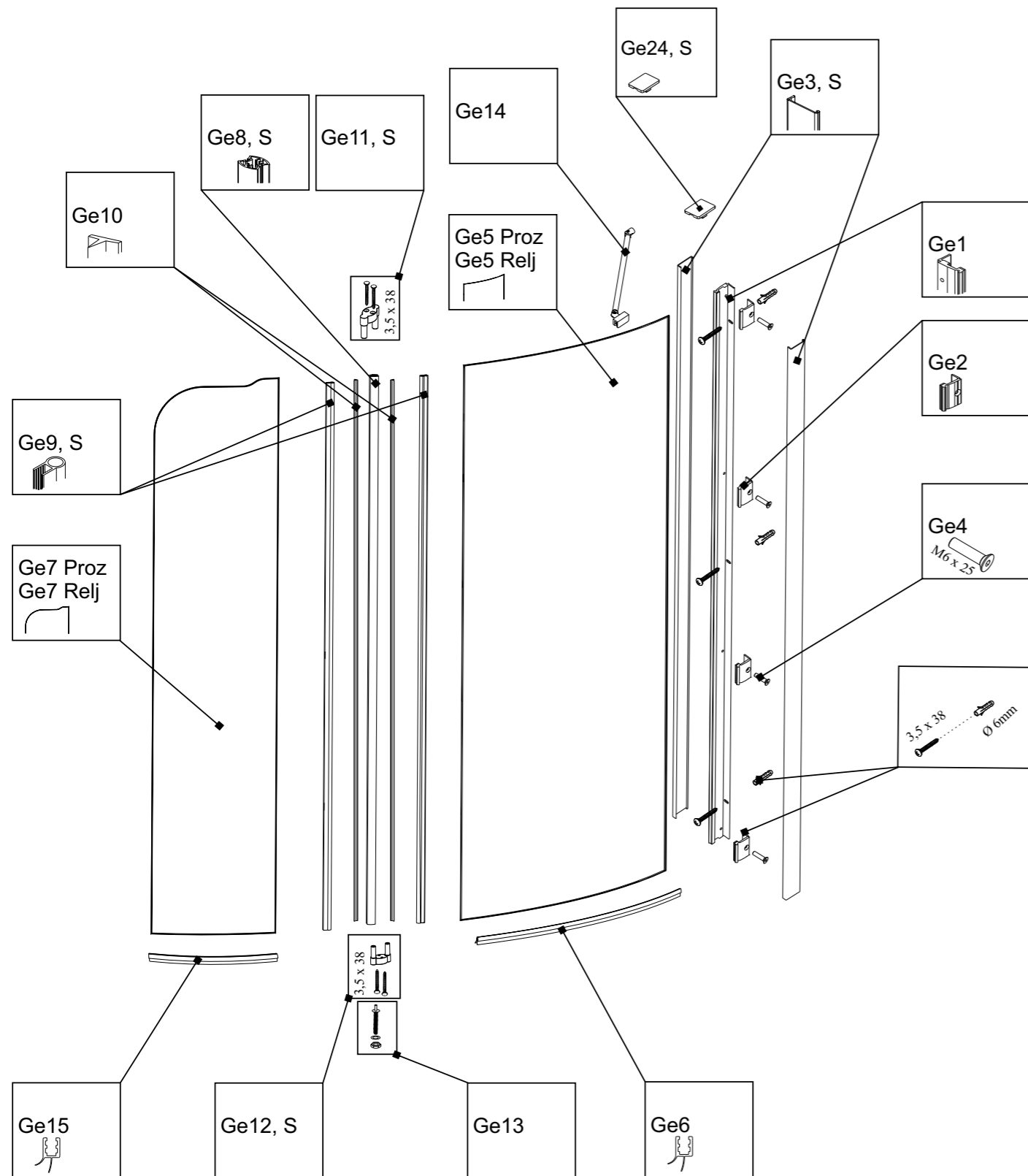

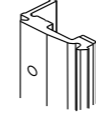
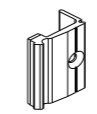
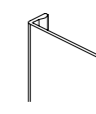
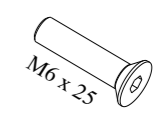

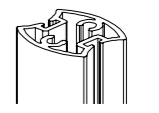

GALAXY	Specif. br.	Šifra	Opis
	Ga6	3112004	PVC profil F60 vertikalni za profil TS-4175, prozir
	Ga7 D, W	3113216	Spojna plastika luk-vert. profil - D, bijela
	Ga7 D, S	3113221	Spojna plastika luk-vert. profil - D, chrom
	Ga8 L, W	3113215	Spojna plastika luk-vert. profil - L, bijela
	Ga8 L, S	3113220	Spojna plastika luk-vert. profil - L, chrom
	Ga9, S	3113205	Poklopac za zid. prof. Savana, Galaxy, Sogno - sivi
	Ga9, W	3113204	Poklopac za zid. prof. Savana, Galaxy, Pandora - bijeli
	Ga10 L, W	3113217	Plastika za učvršćenje fix. stakla - L, bijela
	Ga10 L, S	3113222	Plastika za učvršćenje fix. stakla - L, chrom
	Ga11 D, W	3113218	Plastika za učvršćenje fix. stakla - D, bijela
	Ga11 D, S	3113223	Plastika za učvršćenje fix. stakla - D, chrom
	Ga12, S	3113019	Kotačić za Savanu, gornji, sivi - dupli
	Ga12, W	3113018	Kotačić za Savanu, gornji, bijeli - dupli
	Ga13, S	3113162	Kotačić za Savanu, donji, sivi
	Ga13, W	3113160	Kotačić za Savanu, donji, bijeli
	Ga14, S	3113130	Ukrasna kapica s podloškom, siva
	Ga14, W	3113129	Ukrasna kapica s podloškom, bijela
	Ga15	3112014	PVC profil mag. M 112 V6 L=1985 mm transp. sivi mag
	Ga16, S	3113051	Ručka za tuš kabinu plastična, silver
	Ga16, W	3113050	Ručka za tuš kabinu plastična, bijela
	Ga17	3112015	PVC profil E-503 V6, L=1990mm azurna, za staklo 6 mm
	Ga19	3113091	Stoperi / graničnici za kotačiće, transparent

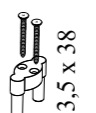
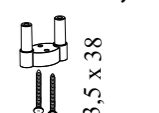



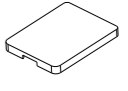





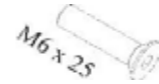



Ge5 Proz Ge5 Relj  x1	Ge6  x1	Ge7 Proz Ge7 Relj  x1	Ge8, W  x1
Ge9, W  x2	Ge10  x2	Ge11, W  x1	Ge12, W  x1
Ge13  x1	Ge14  x1	Ge15  x1	Ge17, W  x1
Ge18, W  x1	Ge19 L  x1	Ge20 D  x1	Ge21, W  x3
Ge22  x2			
Ge23  3 X  3 X  3 X			









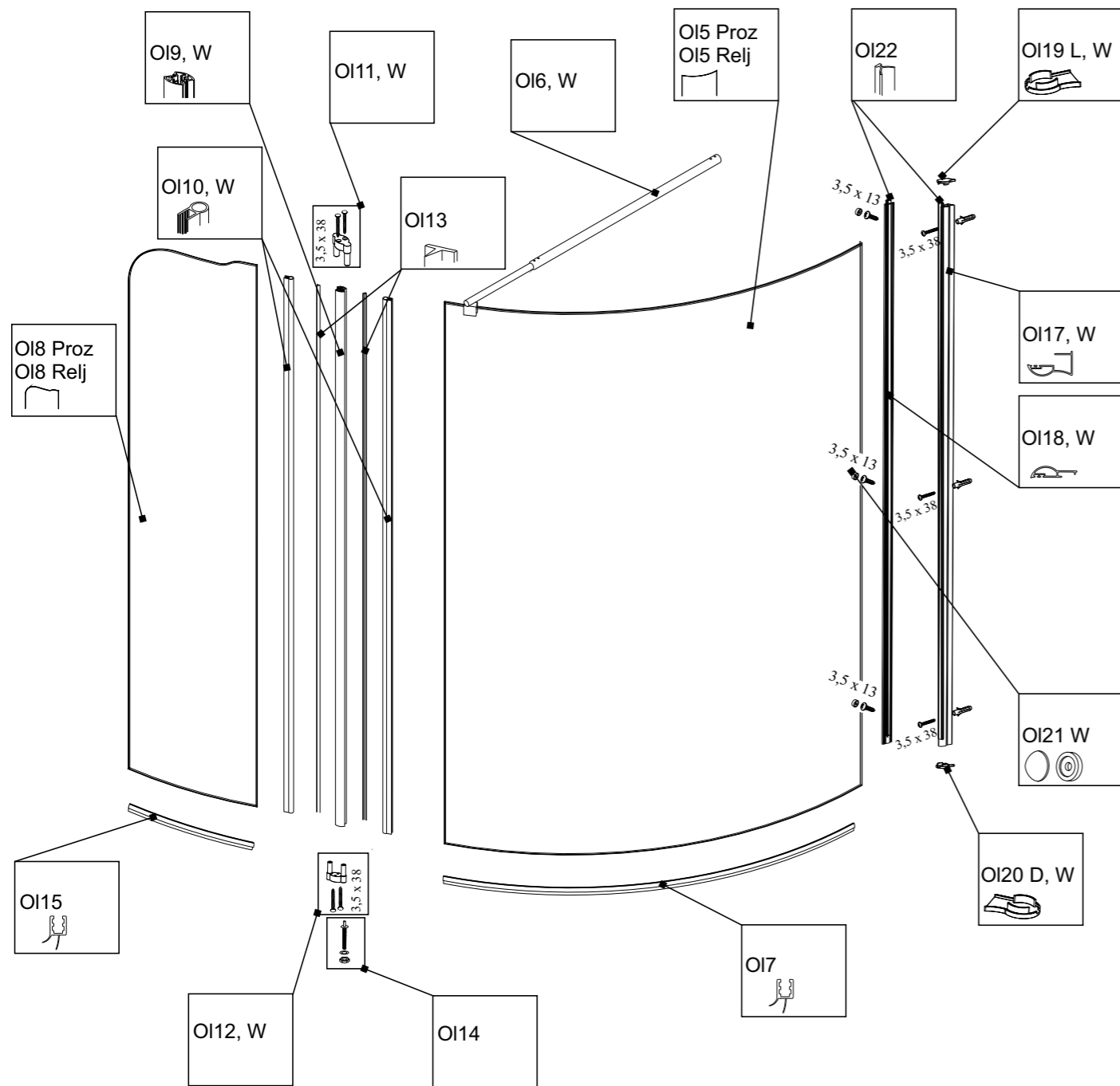







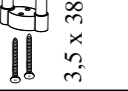

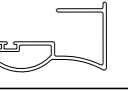
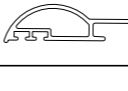

<p>Ge1</p>  <p>x1</p>	<p>Ge2</p>  <p>x4</p>	<p>Ge3, S</p>  <p>x2</p>	<p>Ge4</p>  <p>M6 x 25 x4</p>
<p>Ge5 Proz Ge5 Relj</p>  <p>x1</p>	<p>Ge6</p>  <p>x1</p>	<p>Ge7 Proz Ge7 Relj</p>  <p>x1</p>	<p>Ge8, S</p>  <p>x1</p>
<p>Ge9, S</p>  <p>x2</p>	<p>Ge10</p>  <p>x2</p>	<p>Ge11, S</p>  <p>3,5 x 38 x1</p>	<p>Ge12, S</p>  <p>3,5 x 38 x1</p>
<p>Ge13</p>  <p>x1</p>	<p>Ge14</p>  <p>x1</p>	<p>Ge15</p>  <p>x1</p>	<p>Ge24, S</p>  <p>x1</p>
<p>Ge16</p>   <p>3 X 3 X</p>			









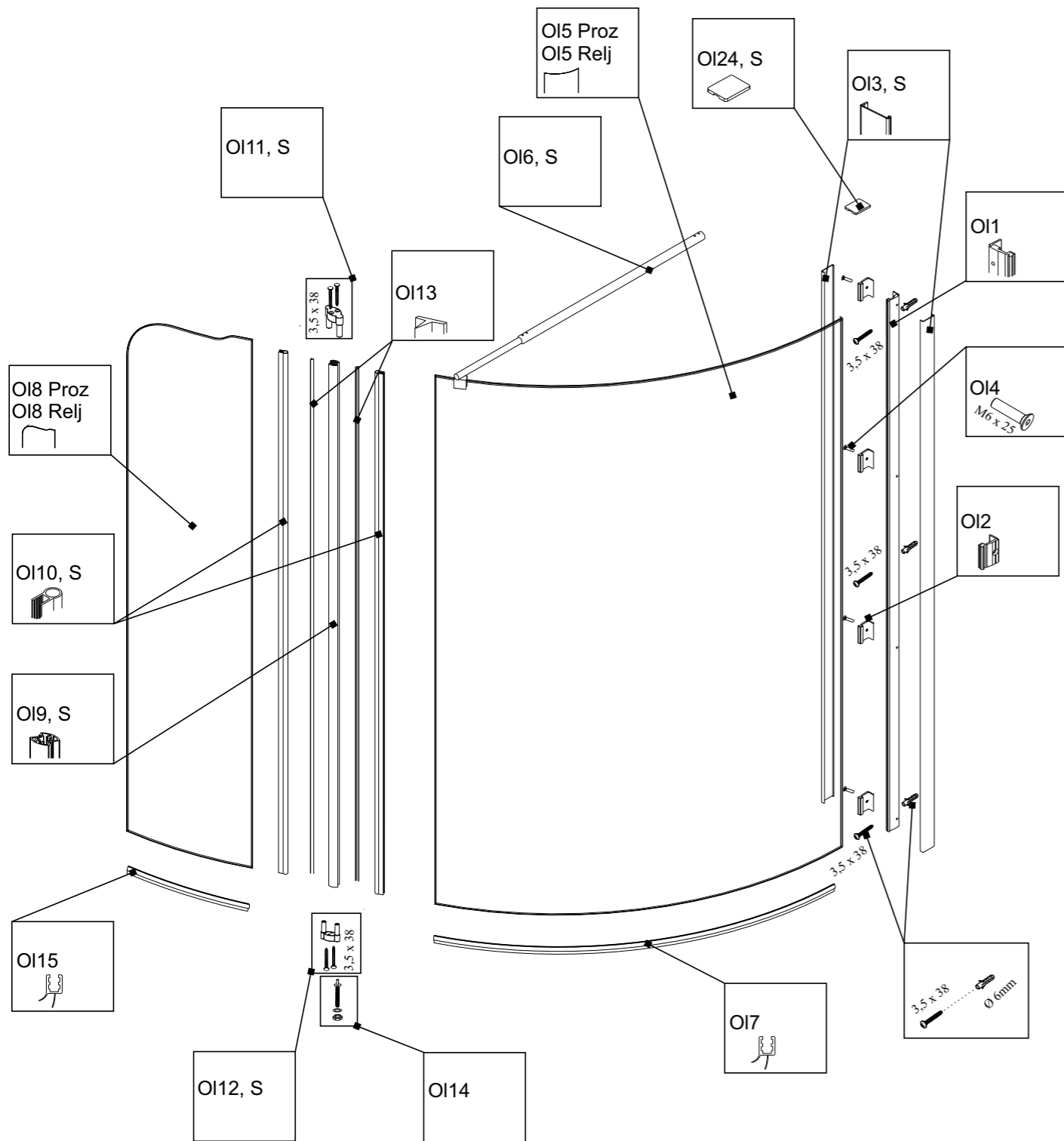

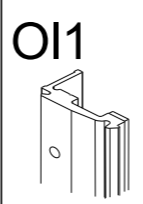
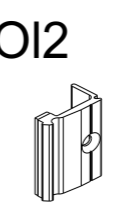
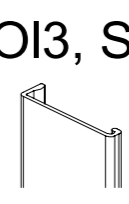

GEMMA	Specif. br.	Šifra	Opis
 M6 x 25	Ge4	3113203	Vijak M6x25 DIN 7991 rostfrei A2
	Ge6 Ge15	3112016	PVC profil E-504 V6, L=2000 mm azur, za st. 6 mm - TITAN
	Ge10	3112029	PVC profil H7 - Titan - spojni profili, L=2000 mm
 3,5 x 38	Ge11 S	3113178	Gornja spojna plast, spojni pr, crna - Titan II U
	Ge11 W	3113244	Gornja spojna plast, spojni pr, bijela - Titan II U
 3,5 x 38	Ge12 S	3113177	Donja spojna plast, spojni pr, crna - Titan II U
	Ge12 W	3113243	Donja spojna plast, spojni pr, bijela - Titan II U
	Ge13	3113147	Navojna šipka M6x50, inox
	Ge14	3113029	Metalna šipka za kutno fiksiranje, 40 cm, chrom
	Ge19 L	3113156	Završna plastika za prof. 4199-4200, L, bijela
	Ge20 D	3113155	Završna plastika za prof. 4199-4200, D, bijela
	Ge21 W	3113129	Ukrasna kapica s podloškom, bijela
	Ge22	3112013	PVC profil ART.375, L=1990 mm, za Oasis D
	Ge24, S	3113209	Poklopac za zidni profil Eris - chrom

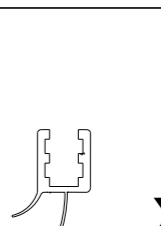

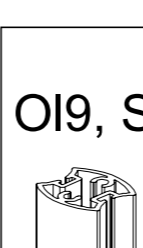
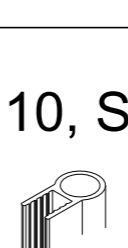
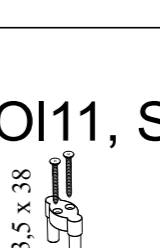

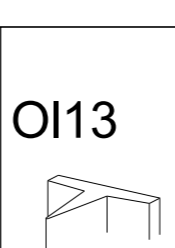
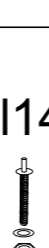
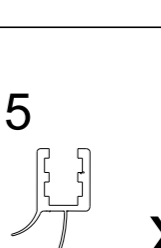

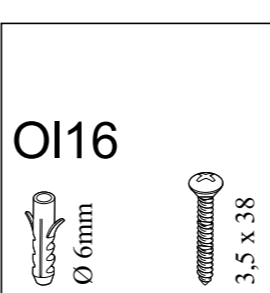



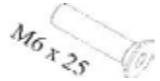



- | | | | |
|---|---|---|--|
| OI5 Proz
OI5 Relj
 x1 | OI6, W
 x1 | OI7
 x1 | OI8 Proz
OI8 Relj
 x1 |
| OI9, W
 x1 | OI10, W
 x2 | OI11, W
 x1 | OI12, W
 x1 |
| OI13
 x2 | OI14
 x1 | OI15
 x1 | OI17, W
 x1 |
| OI18, W
 x1 | OI19 L, W
 x1 | OI20 D, W
 x1 | OI21, W
 x3 |
| OI22
 x2 | | | |
| OI23
 3 X  3,5 x 13 3 X  3,5 x 38 3 X | | | |

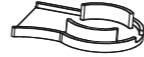

 <p>OI1 x1</p>	 <p>OI2 x4</p>	 <p>OI3, S x2</p>	 <p>OI4 M6 x 25 x4</p>
 <p>OI5 Proz OI5 Relj x1</p>	 <p>OI6, S x1</p>	 <p>OI7 x1</p>	 <p>OI8 Proz OI8 Relj x1</p>
 <p>OI9, S x1</p>	 <p>OI10, S x2</p>	 <p>OI11, S 3,5 x 38 x1</p>	 <p>OI12, S 3,5 x 38 x1</p>
 <p>OI13 x2</p>	 <p>OI14 x1</p>	 <p>OI15 x1</p>	 <p>OI24, S x1</p>
 <p>OI16 3 x 3 3 x 3</p>			



OLBIA	Specif. br.	Šifra	Opis
 M6 x 25	OI4	3113203	Vijak M6x25 DIN 7991 rostfrei A2
	OI6, S	3111083	Šipka za fiksiranje stijene, chrom
	OI6, W	3111084	Šipka za fiksiranje stijene, bijela
	OI7/OI15	3112016	PVC profil E-504 V6, L=2000 mm azurna, za staklo 6mm - TITAN
 3,5 x 38	OI11, S	3113178	Gornja spojna plast, spojni pr, crna - Titan II U
	OI11, W	3113244	Gornja spojna plast, spojni pr, bijela - Titan II U
 3,5 x 38	OI12, S	3113177	Donja spojna plast, spojni pr, crna - Titan II U
	OI12, W	3113243	Donja spojna plast, spojni pr, bijela - Titan II U
	OI13	3112029	PVC profil H7 - Titan - spojni profili, L=2000 mm
	OI14	3113147	Navojna šipka M6x50, inox
	OI19 L, W	3113156	Završna plastika za prof. 4199-4200, L, bijela
	OI20 D, W	3113155	Završna plastika za prof. 4199-4200, D, bijela
	OI21	3113129	Ukrasna kapica s podloškom, bijela
	OI22	3112013	PVC profil ART.375, L=1990 mm, za Oasis D
	OI24, S	3113209	Poklopac za zidni profil Eris - chrom

AQUAESTIL

Aquaestil plus d.o.o.

Lastovska ulica 12a
10000 Zagreb, Hrvatska

Izložbeno edukacijski centar i veleprodaja
Poslovni park 1 b, Belajske Poljice,
47250 Duga Resa, Hrvatska
Tel. +385 (0)47 / 811 - 836
Fax. +385 (0)47 843 - 025

info@aquaestil.hr
www.aquaestil.hr